

General Catalog

DREAM NAVIGATOR
SINCE 1909



NC

Rotary Tables



TSUDAKOMA Corp.

Productivity Innovation

Tsudakoma products are being used all over the world for high-precision machining in the automobile, aerospace, electronics and medical industries. In pursuit of the ultimate in performance, productivity, and technical advantages, Tsudakoma always strives to develop innovative products. We are trying to create advantageous NC tables that best suit your needs.



Aerospace/Parts



Energy



Medical

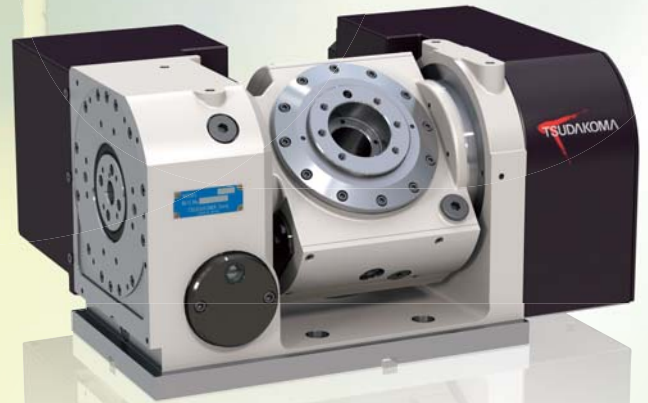

Electronics

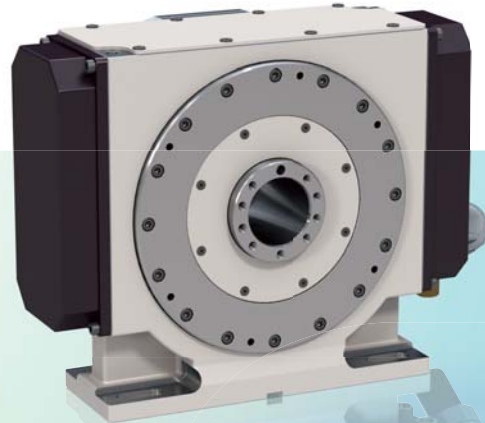

Automotive



General Catalog

NC Rotary Tables

I N D E X

Features	4	INDEX	8
----------	---	-------	---

BallDrive NC Rotary Tables

Basic model	Standard type	RBS	10
-------------	---------------	------------	----

BallDrive NC Tilting Rotary Tables

Basic model	Standard type	TBS	12
-------------	---------------	------------	----

NC Rotary Tables

Basic model	Standard type	RWE/RWA/RN	14
	Rear motor mounting type	RWE/RWA-B/RNCV-B	16
	Vertical motor mounting type	RNCM	18
Big bore model	Standard type	RWB	20
	For horizontal machining centers	RWB-K/RNCK	22
Large models	For horizontal setting	RCH/RNC	24
	Horizontal motor mounting type	RCV/RNCV	26
Multi-spindle models	Multi-spindle type	RWM	28

NC Tilting Rotary Tables

Basic model	Standard type	TWA/TN	30
	Standard type	TTNC	32
	Manual Tilting type	THNC	34
Multi-spindle models	Multi-spindle type	TWM	36

DD Table•Special NC Rotary Tables

SmartDD	RDS	38	DD Table	RTV/RTT	39
High-rigidity models with a super big bore	RCB	40			

Single-axis NC Controllers TPC-Jr/TPC5

TPC-Jr Features and Functions	41	Installation of TPC Controller	48
TPC5 Features and Functions	43	TPC Controllers to Interlock with Machining Tools	49
Specifications	45	Time Chart	50
Option	46	TPC Standard Cable Specifications	50
TPC Machining Program Examples	47	NC Rotary Tables/TPC-Jr Dimensions and Specifications	51
Remote mode + M-specification	47		

Accessories

Chuck	54	Support Spindle	59
Tailstock	57	Face Plate	60

Optional Specifications

Rotary Encoders and MP Scales	61	Pallet Clamp	64
Pull Stud	63	Air-hydraulic Booster	64
Rotary Joint	63		

Technical Information

Explanation of Technical Terms	65	To Make The Best Use	69
Applicable Servo Motors	66	To Select The Best Model	70
Applicable Cable Connectors	66	Inspection Standard	71
Flow Chart of Control System	67	CAUTION	76
Indexing Cycle Time	67		

Workpiece mounting space for tilting rotary tables **68**

TSUDAKOMA Original Next-Generation Drive mechanism

『BallDrive[®]』

The perfect drive system 'BallDrive[®]' realizes the highest accuracy level and no-backlash.

No-clamp machining at a light load with no-backlash, high speed and high rigidity.

Shorten cycle time to improve your productivity by zeroizing of clamp/unclamp time and more than double indexing speed ※

Cycle time reduction

Twice as fast as the current model
Clampless machining

Power saving

High transfer efficiency with a ball rolling system

No backlash

High accuracy machining without backlash

High rigidity

Stable positioning using a powerful clamp

Maintenance free

Extremely small aged deterioration
Original precision is maintained

※In-house comparison

EXCELLENT BALANCE OF SMOOTHNESS, POWER AND DURABILITY BY SPECIAL GEAR SYSTEM ASSURES THE ULTIMATE IN PERFORMANCE

TSUDAKOMA specially designed double-lead worm gears with full-depth teeth

The setting of the lead amount on this gear system is different depending on the rotating direction of the worm wheel and the worm spindle. By moving the worm spindle axially, the tooth engagement can be changed successively. As the backlash between the worm wheel and the worm spindle can be adjusted while keeping them in their proper positions, the ideal tooth engagement is maintained.



Gear system

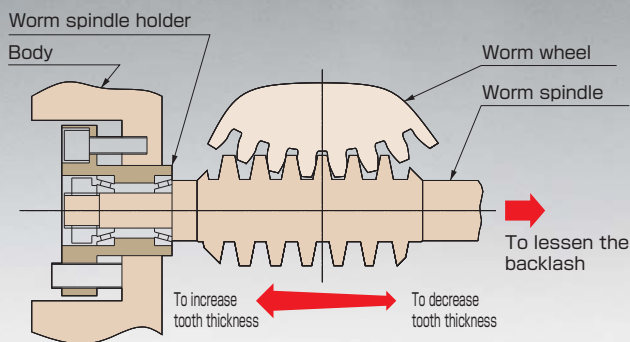

Materials

Worm spindle: Case-hardened alloy steel
Worm wheel: Special high-tensile brass equal in strength to a steel alloy

Torque transfer efficiency

The combination of iron and brass produces less friction. A more effective transfer of the motor torque is achieved compared with other combinations of materials.

Larger worm wheel

The worm wheel with a large pitch diameter creates a large engagement area and less pressure on the contact surface, resulting in high durability against wear compared with conventional gear system.

Tooth profile

The adoption of full-depth gear teeth, instead of standard teeth, results in higher strength equal to that of a gear of a size larger in module.

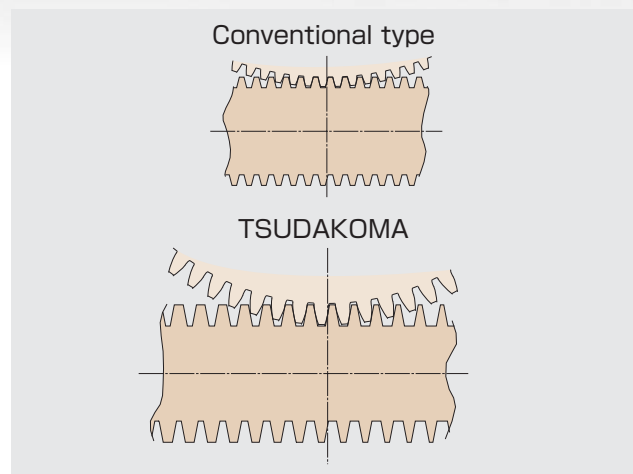
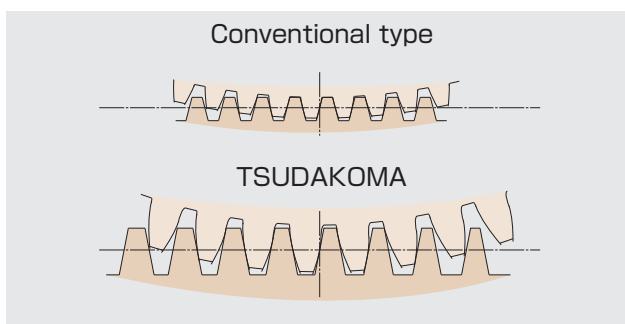

RBS

TBS

RWE/RWA
RN

RWE/RWA-B
RNCV-B

RNCM

RWB

RWB-K
RNCK

RCH
RNC

RCV
RNCV

Multi-Spindle
RWM

TWA/TN

TTNC

THNC

Multi-Spindle
TWM

RDS

RTV
RTT

RCB

NC Controllers

Accessories

Options

Technical
Information

HIGH-LEVEL PERFORMANCE PROVEN IN MACHINING FIELDS

BallDrive NC Rotary Tables

Basic model

RBS-series

High-performance model with the drive system uniquely developed



No backlash

Ideally meshing rolling of steel balls with cam shaft achieves no backlash, 'play' at drive parts. It realizes the highest accuracy level for both indexing accuracy and repeatability.

High Speed

It enables smaller speed reduction ratio comparing with other drive system and more than twice as fast as worm gear. ※

High rigidity

High rigidity of BallDrive enables strong clamp and no-clamp machining at a light load.

BallDrive NC Tilting Rotary Tables

Basic model

TBS-series

High-end Next-Generation model pursuing productivity improvement



No backlash

Ideally meshing rolling of steel balls with cam shaft achieves no backlash, 'play' at drive parts. Machining accuracy and wear resistance is excellent in simultaneous 5-axis machining.

High Speed

It enables smaller speed reduction ratio comparing with other drive system and more than twice as fast as worm gear at both rotary and tilt axis. ※

High rigidity

High rigidity of BallDrive enables strong clamp and no-clamp machining at a light load. ※

※In-house comparison

NC Rotary Tables

Basic models

RWE/RWA-series

New standard for the ultimate in power and speed



High Speed

The specially designed double-lead worm gear system with full-depth teeth of increased torque transfer efficiency minimizes the speed reduction ratio, improving the indexing speed. The machining cycle time is reduced.

Strong Clamp Torque(RWA-series)

The newly developed clamp mechanism using pneumatic pressure realizes powerful clamping. The cutting feed speed is increased. Responsivity is also increased.

Big bore models

RWB-series

Flagship models of single-axis NC table



Newly developed strong hydraulic clamping system

New clamping system enables 25% stronger clamping torque than previous model. It realizes stable machining at a distance from rotary center.

Strong strength of worm gears

Strength of worm gears improves 70% to 130% higher than previous model. It realizes 1 size stronger strength than previous model, which provides downsizing of the model.

Indexing accuracy 14 sec.(the sum) guaranteed

Our high quality control enable us to take an another step forward to elevate the indexing accuracy.

NC Tilting Rotary Tables

Basic tilting models

TWA/TN-series

Best partner for five-axis machining



High Speed

The specially designed double-lead worm gear system with full-depth teeth of increased torque transfer efficiency minimizes the speed reduction ratio, improving the indexing speed. The machining cycle time is reduced.

Strong Clamp Torque

The newly developed clamp mechanism using pneumatic pressure realizes powerful clamping. It is rigid enough for machining even at a position far from the tilting axis.

Variety of Options

In addition to the automatic work mounting and dismounting arrangements by a pull-stud device as well as pneumatic or hydraulic rotary joint, high precision specifications using a scale is also available.

RBS

TBS

RWE/RWA
RN

RWE/RWA-B
RNCV-B

RNCM

RWB

RWB-K
RNCK

RCH
RNC

RCV
RNCV

Multi-Spindle
RWM

TWA/TN

TTNC

THNC

Multi-Spindle
TWM

RDS

RTV
RTT

RCB

NC Controllers

Accessories

Options

Technical
Information

INDEX

BallDrive NC Rotary Tables

Basic models

It enables high indexing speed and super productivity with top quality thanks to no backlash and high rigidity

Standard type
RBS



RBS-160 P.10
RBS-250
RBS-320

Standard type
TBS



TBS-130 P.12
TBS-160
TBS-250

NC Rotary Tables

Powerful, Compact and Speedy!
Products for processes ranging from high-speed multi-axis drilling and tapping to cam machining

Basic models

Best-selling models with strong clamp torque and outstanding water-proof structure

Standard type
RWE/RWA
RN



RWE-160 P.14
RWE-200
RWA-160
RWA-200
RWA-250
RWA-320
RN-100

Tilting Vertical motor mounting type
RNCM



RNCM-251 P.18
RNCM-301
RNCM-401
RNCM-501
RNCM-631

Rear motor mounting type
RWE/RWA-B
RNCV-B



RWE-160R,B P.16
RWE-200R,B
RWA-160R,B
RWA-200R,B
RWA-250R,B
RWA-320R,B
RNCV-401R,B

Big bore models

Our flagship model various types of labor-saving and automation devices can be attached through the large-diameter bore

Standard type
RWB



RWB-250 P.20
RWB-320
RWB-400
RWB-500

For horizontal machining centers
RWB-K
RNCK



RWB-250K P.22
RWB-320K
RWB-400K
RWB-500K
RNCK-631

Large models

A top-seller large-capacity model when combined with large-sized double column, or 5-face machining centers

For horizontal setting
RCH
RNC

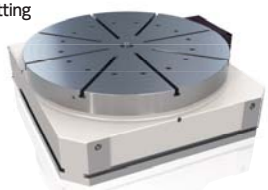

RCH-800 P.24
RCH-1000
RCH-1250
RNC-1501
RNC-2001

Horizontal motor mounting type
RCV
RNCV



RCV-800 P.26
RCV-1000
RCV-1250
RNCV-1501

Multi-spindle models High-productivity model for multi-piece/multi-face machining

Multi-spindle type
RWM



RWM-160-2/3/4 P.28
RWM-200-2/3/4

Single-axis NC Controllers

NC table can be controlled with M-signals from the machining centers

For small NC rotary tables
TPC-Jr



TPC-Jr K2 P.41
TPC-Jr K3

For large NC rotary tables
TPC5



TPC5 SR6 P.43
TPC5 SR12
TPC5 SR30

NC Tilting Rotary Tables

Machining of aluminum components for automobiles electronic devices and blades for jet engines

Basic models

High speed indexing and strong clamp torque for 5-axis machining

Standard type

TWA/TN



TWA-100 P.30
TWA-130
TWA-160
TWA-200
TN-320
TN-450

Manual Tilting type

THNC



THNC-251 P.34
THNC-301

Standard type

TTNC



TTNC-631 P.32
TTNC-1001
TTNC-1500

Multi-spindle models

Multi-work processing model for high productivity

Multi-spindle type

TWM



TWM-160 P.36
TWM-250

DD Table•Special NC Rotary Tables

DD Table

RDS

RTV•RTT



RDS-200 P.38
RTV-202 P.39
RTT-112

Highly rigid models with a super big bore

RCB

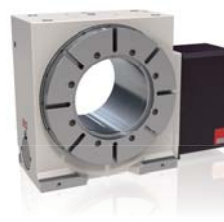

RCB-350 P.40
RCB-450
RCB-550

Accessories

P.54

Chuck

Scroll chuck



Power chuck



Tailstock

Manual tailstock



Hydraulic tailstock



Support spindle



Face plate



Optional Specifications

P.61

Rotary encoders and MP scales for high precision

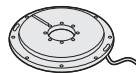

Pull-stud

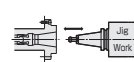

Rotary joint

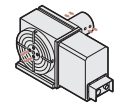

Pallet clamp

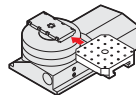

Air-hydraulic Booster



RBS

TBS

RWE/RWA
RN

RWE/RWA-B
RNCV-B

RNCM

RWB

RWB-K
RNCK

RCH
RNC

RCV
RNCV

Multi-Spindle
RWM

TWA/TN

TTNC

THNC

Multi-Spindle
TWM

RDS

RTV
RTT

RCB

NC Controllers

Accessories

Options

Technical
Information

Standard type

RBS RBS-160•250•320









RBS-160

Unit: mm

We provide you the top productivity and high-grade machining with no backlash and high indexing speed, two times faster than previous model.

Specifications

		RBS-160	RBS-250	RBS-320
Handedness	R	○	○	○
	L	○	○	○
Spindle diameter		φ 100	φ 140	φ 180
Table diameter*1		φ 160 or φ 200 (Option)	φ 250 (Option)	φ 320 (Option)
Center height		160	210	255
Center bore	Nose diameter	φ 55H7×45	φ 80H7×45	φ 115H7×45
	Through-bore	φ 40	φ 50	φ 85
Table T-slot width*1		12H8	12H8	14H8
Guide block width		14 h 7	18 h 7	18 h 7
Servo motors (for FANUC)		α iS4	α iS8	α iS12
Inertia converted into motor shaft × 10 ⁻³ kg·m ²		0.19	0.42	2.24
Net weight kg		60	110	210
Speed reduction ratio		1/36	1/36	1/36
Table max. rpm min ⁻¹ (Motor rpm: 3,000min ⁻¹)		83.3	83.3	83.3
Indexing accuracy (the sum) sec		15	15	15
Clamp system		Pneumatic	Pneumatic	Pneumatic
Clamp torque N·m /pneumatic pressure 0.49MPa		250 (500)*2	600 (1,000)*2	1,000 (1,500)*2
Accessories	Vertical setting  kg	100 (200)	125 (250)	175 (350)
	() :with tailstock			
Options	Horizontal setting  kg	200	250	350
	Technical Information			
Allowable load (when table is clamped)	F  N	10,800	14,400	24,800
	F×L  N·m	250 (500)*2	600 (1,000)*2	1,000 (1,500)*2
	F×L  N·m	780	1,900	4,700
Allowable work inertia $J = \frac{W \cdot D^2}{8}$  kg·m ²	0.64	1.95	4.48	

 Servo motors of other manufacturers **P.66**

 When assembling a faceplate or a fixture with the main spindle (RNA-B-series) **P.76**

* 1 The tolerance of the table T-slot width is applicable to four standard slots arranged crosswise.  Dimensions **P.60**

* 2 High Clamp Torque model.

Dimensions

Unit:mm

RBS-160

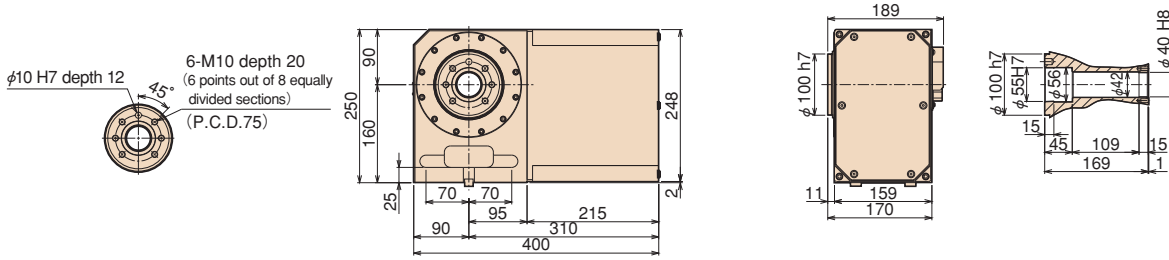

RBS-250

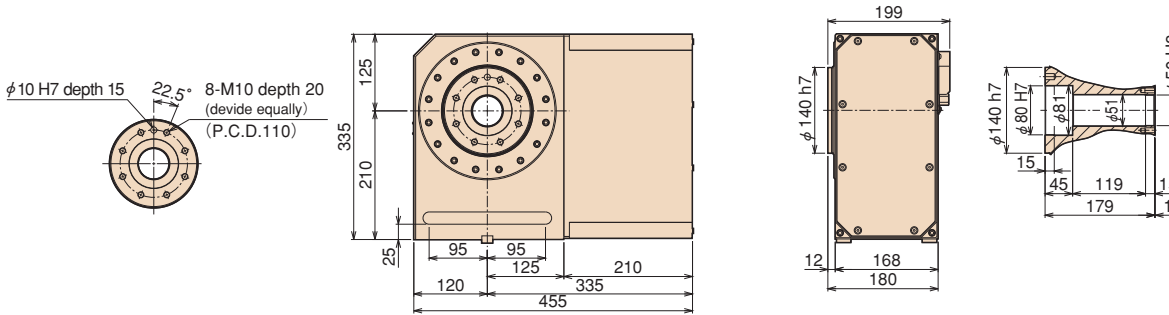

RBS-320

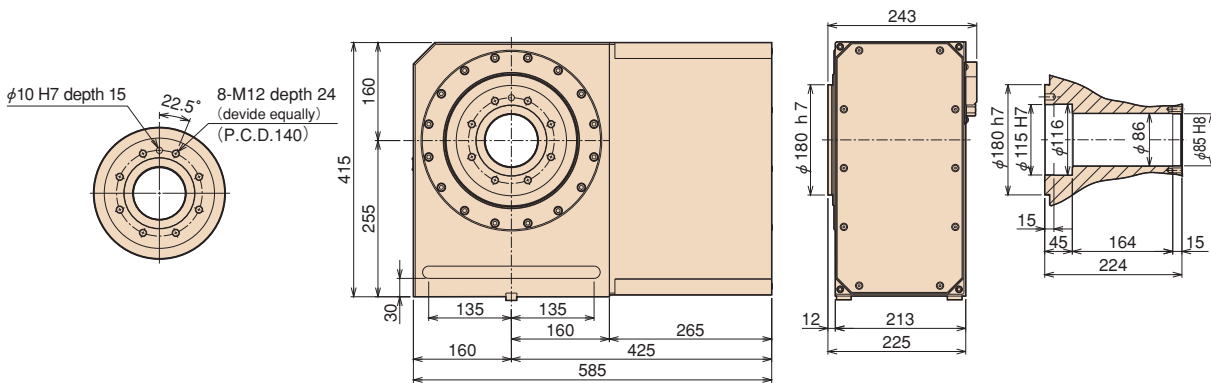

Note: The above dimensions are for FANUC servo motors. The dimensions of servo motors of other manufacturers may be larger.

- RBS**
- TBS**
- RWE/RWA
RN
- RWE/RWA-B
RNCV-B
- RNCM**
- RWB**
- RWB-K
RNCK
- RCH**
RNC
- RVC
RNCV
- Multi-Spindle
RWM
- TWA/TN
- TTNC**
- THNC**
- Multi-Spindle
TWM
- RDS**
- RTV
RTT
- RCB**
- NC Controllers
- Accessories
- Options
- Technical Information

Clamping block and bolt

Unit: mm

	Q'ty	T-slot pitch	T-slot width	A	B	C	D	E	F	G	H	I	J	K	L	M
RBS-160	2	—	14	—	—	—	—	—	—	—	17	8	60	—	23	12
RBS-250	4	40~120	18	25	12	80	12	33	35	22	21	11	65	40	28	16
RBS-320	4	55~147	18	30	15	90	16	31	43	25	21	11	70	46	28	16

Note 1: When using a machine with a T-slot pitch other than the above, use suitable clamping blocks and bolts that are available on the market, or order custom-made ones from TSUDAKOMA. (Option)

Type I

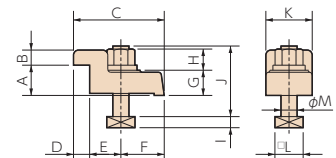

Standard type

TBS TBS-130•160•250









TBS-160

Unit: mm

The latest technology, tilting rotary tables with Tsudakoma BallDrive system are joined in our line-up to provide perfect performance in 5-axis machining and to contribute to improve productivity.

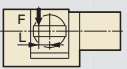
Specifications

		TBS-130		TBS-160		TBS-250	
Tilt range		-30° ~ +110°		-30° ~ +110°		-30° ~ +110°	
Spindle diameter		φ 90 h7		φ 100 h7		φ 140 h7	
Table diameter *1		φ 135		φ 160 or 200 (Option)		φ 250	
Table height at 0° position		225 (250 W/face plate)		270 (300 W/face plate)		290 (320 W/face plate)	
Center height at 90° position		160		200		235	
Center bore	Nose diameter	φ 55H7 (φ 40H7 W/face plate)		φ 55H7 (φ 50H7 W/face plate)		φ 80H7 (φ 75H7 W/face plate)	
	Through-bore	φ 40		φ 40		φ 50	
Table T-slot width *1		12H8(W/face plate)		12H8 (W/face plate)		12H8(W/face plate)	
Guide block width		14h7		18h7		18h7	
Servo motors (for FANUC)	Rotary axis		Tilt axis	Rotary axis	Tilt axis	Rotary axis	Tilt axis
		αiS2	αiS2	αiS2	αiS4	αiS8	αiS8
Inertia converted into motor shaft	× 10 ⁻³ kg·m ²	0.121	0.140	0.155	0.168	0.586	0.465
Speed reduction ratio		1/48	1/60	1/60	1/60	1/45	1/60
Table max. rpm	min ⁻¹ (Motor rpm: 3,000min ⁻¹)	62.5	50	50	50	66.6	50
Clamp system	Supplied pressure	Pneumatic	Pneumatic	Pneumatic	Pneumatic	Pneumatic	Pneumatic
Clamp torque	∕ pneumatic pressure 0.49MPa N·m	250 (500) *2	250 (500) *2	250 (500) *2	250 (500) *2	600 (1,000) *2	600 (1,000) *2
Indexing accuracy (the sum)	arc sec	20	—	20	—	20	—
Tilting accuracy	Tilt 0° ~ 90° arc sec	—	30	—	30	—	40
Net weight	kg	120		160		280	
Options	0° (Horizontal)	 kg	35	60	135		
	Allowable work weight 0° ~ 90° (Tilting)	 kg	20	40	85		
Technical Information	Allowable work moment W×L	 N·m	61.1	59.6	186.7		
	Allowable load F	 N	3,920	10,800	14,400		
Technical Information	Allowable load (when table is clamped) F×L	 N·m	250 (500) *2	250 (500) *2	600 (1,000) *2		
	F×L	 N·m	250 (500) *2	250 (500) *2	600 (1,000) *2		
Allowable work inertia	$J = \frac{W \cdot D^2}{8}$	 kg·m ²	0.08	0.19	1.05		

☞ Servo motors of other manufacturers **P.66**

☞ When assembling a faceplate or a fixture with the main spindle **P.76**

* 1 The tolerance of the table T-slot width is applicable to four standard slots arranged crosswise. ☞ Dimensions **P.60**

* 2 High Clamp Torque model.

Dimensions

Unit:mm

TBS-130

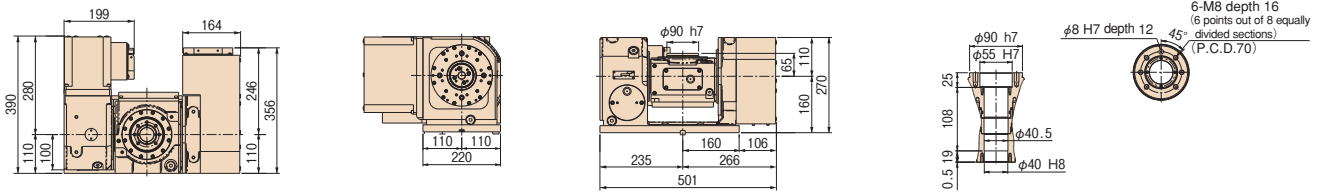

TBS-160

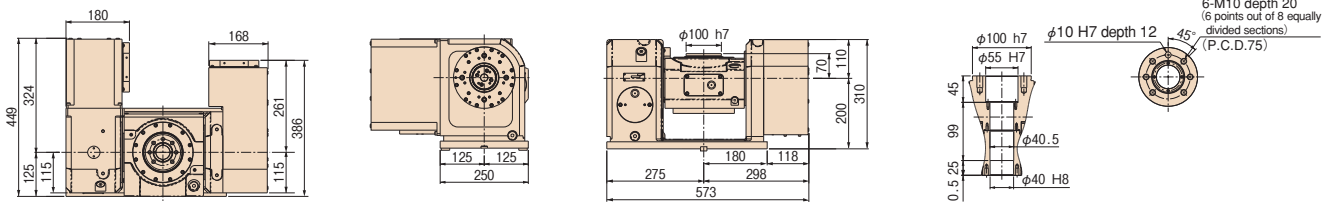

TBS-250

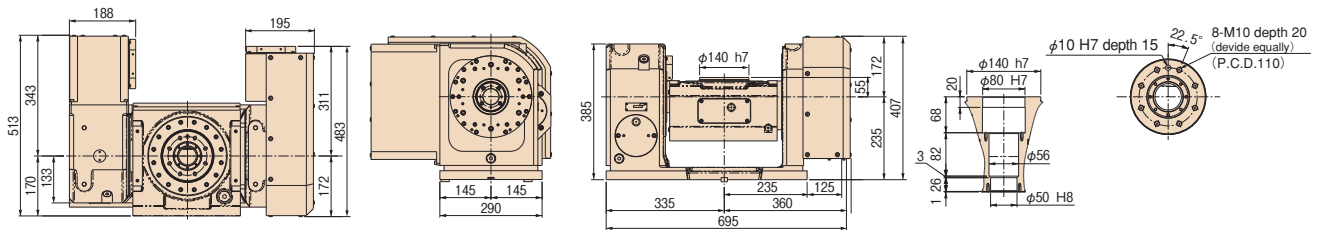

Note: The above dimensions are for FANUC servo motors. The dimensions of servo motors of other manufacturers may be larger.

- RBS
- TBS
- RWE/RWA/RN
- RWE/RWA-B/RNCV-B
- RNCM
- RWB
- RWB-K/RNCK
- RCH/RNC
- RCV/RNCV
- Multi-Spindle/RWM
- TWA/TN
- TTNC
- THNC
- Multi-Spindle/TWM
- RDS
- RTV/RTT
- RCB

- NC Controllers
- Accessories
- Options
- Technical Information

Clamping block and bolt

Unit:mm

	Type	Q'ty	Layout	T-slot pitch	T-slot width	A	B	C	D	E	F	G	H	I	J	K	L	M
TBS-130	I	4	a b	40~134 *	14	20	12	70	10	35	25	20	17	8	55	35	23	12
TBS-160	I	4	a b	78~152 63~107	18	20	12	70	10	35	25	17	15	11	55	35	28	16
TBS-250	I	4	a b	130~215 78~125	18	25	12	80	12	33	35	22	21	11	65	40	28	16

Note 1: * In the case of layout b, contact us for the details about mounting.

Note 2: When using a machine with a T-slot pitch other than the above, use suitable clamping blocks and bolts that are available on the market, or order custom-made ones from TSUDAKOMA. (Option)

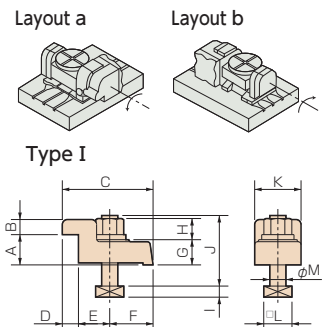

Standard type

RWE/RWA

RWE-160·200
RWA-160·200·250·320

RN RN-100



The RWE/RWA series, an improvement on the best-selling, has remarkably improved cost efficiency due to its high-speed operation for use in drill and tapping machines.

Specifications

Unit: mm

		RWE/RWA-160	RWE/RWA-200	RWA-250	RWA-320	RN-100	
Handedness	R	○	○	○	○	○	
	L	○	○	○	○	○	
Spindle diameter		φ 100	φ 120	φ 140	φ 180	φ 80	
Table diameter*1		φ 160 or 200 (Option)	φ 200 or 250 (Option)	φ 250 (Option)	φ 320 (Option)	φ 135 (Option)	
Center height		135	160	160	210	110	
Center bore	Nose diameter	φ 55H7×45	φ 65H7×45	φ 80H7×45	φ 115H7×45	φ 50H7×45	
	Through-bore	φ 40	φ 45	φ 50	φ 85	φ 30	
Table T-slot width*1		12H8	12H8	12H8	14H8	10H8	
Guide block width		14h7	18h7	18h7	18h7	14h7	
Servo motors (for FANUC)		αiS2	αiS4	αiS8	αiS8	αiF2	
Inertia converted into motor shaft	× 10 ⁻³ kg·m ²	0.09	0.17	0.41	0.52	0.23	
Net weight	kg	40	61	80	150	28	
Speed reduction ratio		1/72	1/72	1/90	1/120	1/36	
Table max. rpm	min ⁻¹ (Motor rpm: 3,000min ⁻¹)	41.6	41.6	33.3	25	83.3	
Indexing accuracy (the sum)		25	20	20	20	45	
Clamp system		Pneumatic	Pneumatic	Pneumatic	Pneumatic	Pneumatic	
Clamp torque / pneumatic pressure 0.49MPa	N·m	250 (RWE)	400 (RWE)	1,000	1,500	80	
		500 (RWA)	800 (RWA)				
Strength of worm gears	N·m	206	288	596	939	176	
Allowable work weight	Vertical setting () : with tailstock	kg	100 (200)	125 (250)	125 (250)	175 (350)	25 (50)
	Horizontal setting	kg	200	250	250	350	50
Allowable load (when table is clamped)	F	N	10,800	14,400	14,400	24,800	5,880
	F×L	N·m	500	800	1,000	1,500	80
	F×L	N·m	780	1,900	1,900	4,700	156
Allowable work inertia	$J = \frac{W \cdot D^2}{8}$	kg·m ²	0.64	1.25	1.95	4.48	0.10

☞ Servo motors of other manufacturers **P.66**

☞ When assembling a faceplate or a fixture with the main spindle (RNA-B-series) **P.76**

* 1 The tolerance of the table T-slot width is applicable to four standard slots arranged crosswise. ☞ Dimensions **P.60**

Dimensions

Unit:mm

RWE/RWA-160

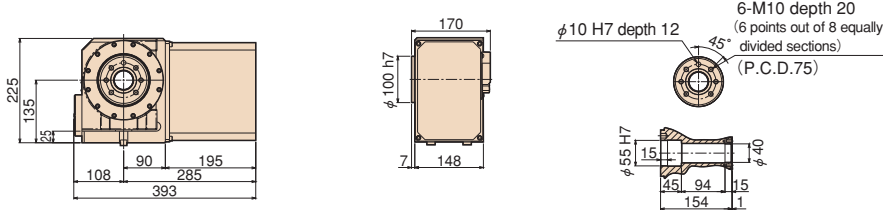

RWE/RWA-200

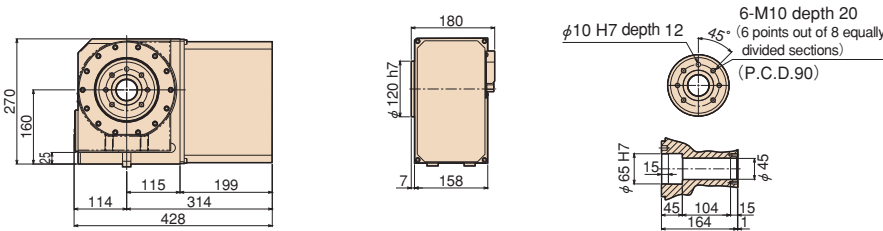

RWA-250

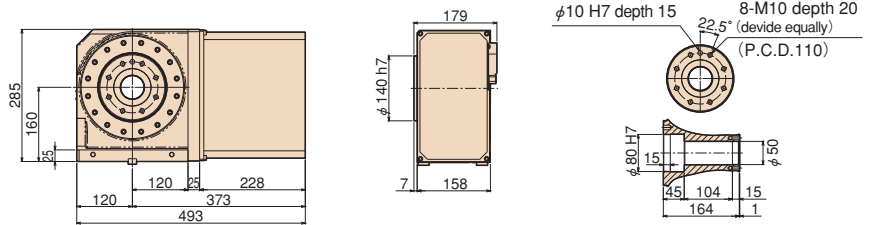

RWA-320

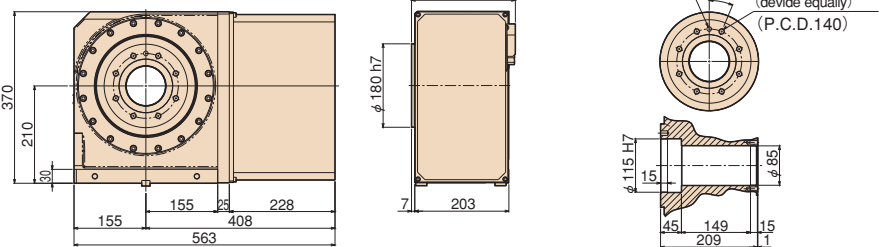

RN-100R

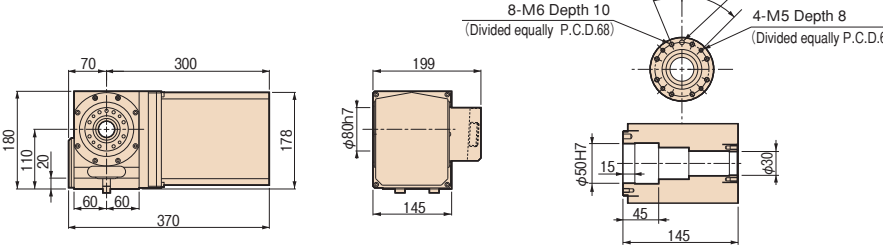

Note: The above dimensions are for FANUC servo motors. The dimensions of servo motors of other manufacturers may be larger.

Clamping block and bolt

	Type	Q'ty	T-slot pitch	T-slot width	A	B	C	D	E	F	G	H	I	J	K	L	M
RWE/RWA-160	—	2	—	14	—	—	—	—	—	—	—	17	8	60	—	23	12
RWE/RWA-200	—	2	—	18	—	—	—	—	—	—	—	21	11	65	—	28	16
RWA-250	I	4	50~100	18	25	12	80	12	33	35	22	21	11	65	40	28	16
RWA-320	I	4	50~132	18	30	15	90	16	31	43	25	21	11	70	46	28	16
RN-100	—	2	—	14	—	—	—	—	—	—	—	17	8	55	—	23	12

Note 1: When using a machine with a T-slot pitch other than the above, use suitable clamping blocks and bolts that are available on the market, or order custom-made ones from TSUDAKOMA. (Option)

Note 2: Clamping blocks are not included with the RWE/RWA-160 and RWE/RWA-200 and RN-100.

Type I

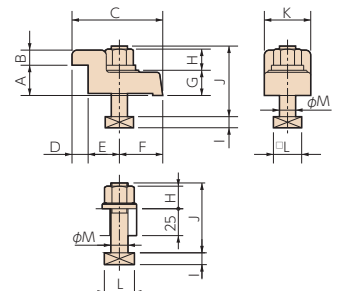

- RBS
- TBS
- RWE/RWA RN**
- RWE/RWA-B RNCV-B
- RNCM
- RWB
- RWB-K RNCK
- RCH RNC
- RCV RNCV
- Multi-Spindle RWM
- TWA/TN
- TTNC
- THNC
- Multi-Spindle TWM
- RDS
- RTV RTT
- RCB
- NC Controllers
- Accessories
- Options
- Technical Information

Rear motor mounting type

RWE/RWA-B

RWE- 160R,B•200R,B
RWA- 160R,B•200R,B•250R,B•320R,B

RNCV-B RNCV-401R,B



RWE-160R,B

One of the most popular rear motor mounting types. Suitable for mounting on a compact machine tool for space saving.

Specifications

Unit: mm

		RWE/RWA-160R,B	RWE/RWA-200R,B	RWA-250R,B	RWA-320R,B	RNCV-401R,B	
Handedness	R	○	○	○	○	○	
	L	—	—	—	—	—	
Spindle diameter		φ 100	φ 120	φ 140	φ 180	—	
Table diameter*1		φ 160 or 200 (Option)	φ 200 or 250 (Option)	φ 250 (Option)	φ 320 (Option)	φ 400	
Center height		135	160	160	210	255	
Center bore	Nose diameter	φ 55H7×45	φ 65H7×45	φ 80H7×45	φ 115H7×45	φ 40H7×21	
	Through-bore	φ 40	φ 45	φ 50	φ 85	φ 40	
Table T-slot width*1		12H8	12H8	12H8	14H8	14H8	
Guide block width		14h7	18h7	18h7	18h7	18h7	
Servo motors (for FANUC)		α iS2	α iS4	α iS8	α iS8	α iF12	
Inertia converted into motor shaft	× 10 ⁻³ kg·m ²	0.56	0.64	0.97	0.84	4.01	
Net weight	kg	55	77	95	165	330	
Speed reduction ratio		1/72	1/72	1/90	1/120	1/180	
Table max. rpm	min ⁻¹ (Motor rpm: 3,000min ⁻¹)	41.6	41.6	33.3	25	11.1	
Indexing accuracy (the sum)	sec	25	20	20	20	15	
Clamp system		Pneumatic	Pneumatic	Pneumatic	Pneumatic	Hydraulic or air-hydraulic (Option)	
Clamp torque /pneumatic pressure 0.49MPa	N·m	250 (RWE)	400 (RWE)	1,000	1,500	1,764 (Hydraulic pressure 3.5Mpa)	
		500 (RWA)	800 (RWA)				
Strength of worm gears	N·m	206	288	596	939	1,666	
Allowable work weight	Vertical setting () : with tailstock	kg	100 (200)	125 (250)	125 (250)	175 (350)	200 (500)
	F 	N	10,800	14,400	14,400	24,800	39,200
Allowable load (when table is clamped)	F×L 	N·m	500	800	1,000	1,500	1,764
	F×L 	N·m	780	1,900	1,900	4,700	2,450
Allowable work inertia	$J = \frac{W \cdot D^2}{8}$ 	kg·m ²	0.64	1.25	1.95	4.48	9.7

Servo motors of other manufacturers **P.66**

When assembling a faceplate or a fixture with the main spindle (RWE/RWA-B-series) **P.76**

* 1 The tolerance of the table T-slot width is applicable to four standard slots arranged crosswise. Dimensions **P.60**

Dimensions

Unit: mm

RWE/RWA-160R,B

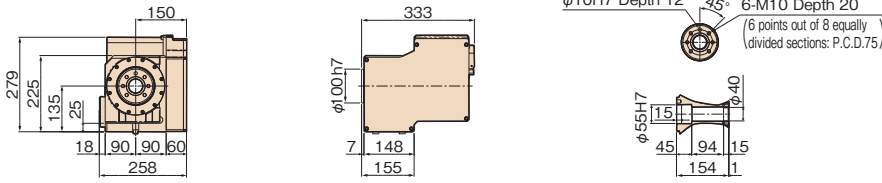

RWE/RWA-200R,B

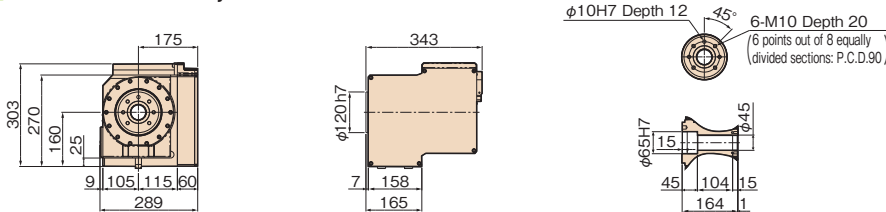

RWA-250R,B

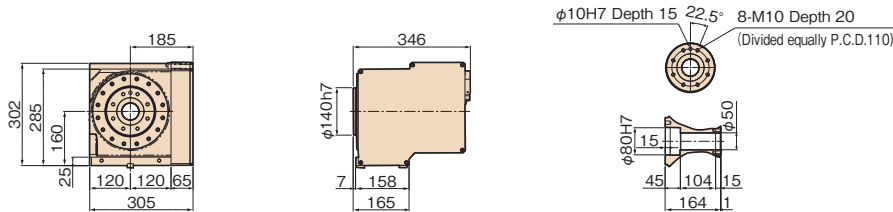

RWA-320R,B

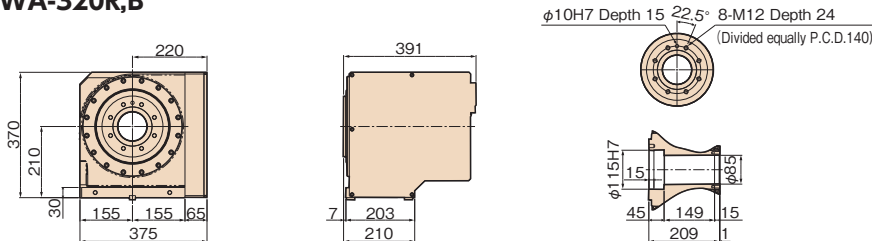

RNCV-401R,B

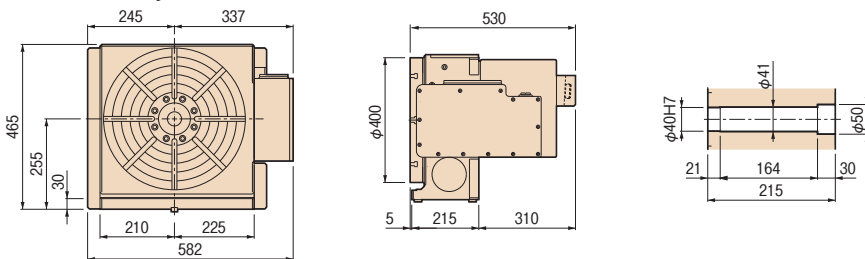

Note: The above dimensions are for FANUC servo motors. The dimensions of servo motors of other manufacturers may be larger.

Clamping block and bolt

	Type	Q'ty	T-slot pitch	T-slot width	A	B	C	D	E	F	G	H	I	J	K	L	M
RWE/RWA-160R,B	—	2	—	14	—	—	—	—	—	—	—	17	8	60	—	23	12
RWE/RWA-200R,B	—	2	—	18	—	—	—	—	—	—	—	21	11	65	—	28	16
RWA-250R,B	I	4	50~100	18	25	12	80	12	33	35	22	21	11	65	40	28	16
RWA-320R,B	I	4	50~132	18	30	15	90	16	31	43	25	21	11	70	46	28	16
RNCV-401R,B	I	4	55~155	18	30	15	90	16	31	43	25	21	11	70	46	28	16

Note 1: When using a machine with a T-slot pitch other than the above, use suitable clamping blocks and bolts that are available on the market, or order custom-made ones from TSUDAKOMA. (Option)

Note 2: Clamping blocks are not included in the RWE/RWA-160R,B and RWE/RWA-200R,B.

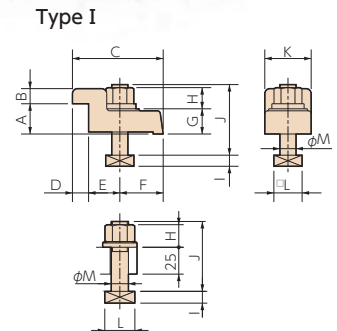

- RBS
- TBS
- RWE/RWA-RN
- RWE/RWA-B RNCV-B
- RNCM
- RWB
- RWB-K RNCK
- RCH RNC
- RCV RNCV
- Multi-Spindle RWM
- TWA/TN
- TTNC
- THNC
- Multi-Spindle TWM
- RDS
- RTV RTT
- RCB
- NC Controllers
- Accessories
- Options
- Technical Information

Vertical motor mounting type

RNCM

RNCM- 251•301•401•501•631





Basic models with a motor horizontally mounted onto the side of the body.



RNCM-301R

Specifications

Unit: mm

		RNCM-251	RNCM-301	RNCM-401	RNCM-501	RNCM-631		
Handedness	R	○	○	○	○	○		
	L	○	○	○	○	○		
Table diameter		φ250	φ320	φ400	φ500	φ630		
Center height		160	210	255	310	400		
Center bore	Nose diameter	φ40H7	φ40H7	φ40H7	φ50H7	φ60H6*2		
	Through-bore	φ32	φ40	φ40	φ50	φ60		
Table T-slot width*1		12H7	14H7	14H7	18H7	18H7		
Guide block width		18h7	18h7	18h7	18h7	18h7		
Servo motors (for FANUC)		αiF4 or αiF8	αiF8	αiF12	αiF12	αiF12		
Inertia converted into motor shaft		$\times 10^{-3} \text{kg} \cdot \text{m}^2$ [$\times 10^{-3} \text{kgf} \cdot \text{cm} \cdot \text{sec}^2$]	0.30 [3.01]	0.34 [3.43]	1.76 [17.9]	2.05 [20.9]	3.09 [31.9]	5.55 [56.6]
Net weight		kg	75	200	300	450	800	
Speed reduction ratio			1/180	1/360	1/180	1/180	1/180	
Table max. rpm		min^{-1} (Motor rpm: 2,000 min^{-1})	11.1	5.5	11.1	11.1	11.1	
Indexing accuracy (the sum)		sec	15	15	15	15	15	
Clamp system			Hydraulic or air-hydraulic (Option)	Hydraulic or air-hydraulic (Option)	Hydraulic or air-hydraulic (Option)	Hydraulic or air-hydraulic (Option)	Hydraulic or air-hydraulic (Option)	
Clamp torque		N·m [kgf·m]	490 [50]	833 [85]	1,764 [180]	2,450 [250]	4,410 [450]	
Strength of worm gears		N·m [kgf·m]	470 [48]	764 [78]	1,666 [170]	2,450 [250]	4,116 [420]	
Allowable work weight	Vertical setting  () : with tailstock	kg	100 (250)	150 (350)	200 (500)	250 (600)	400 (1,000)	
	Horizontal setting 	kg	250	350	500	600	1,000	
Allowable load (when table is clamped)		N [kgf]	19,600 [2,000]	29,400 [3,000]	39,200 [4,000]	49,000 [5,000]	49,000 [5,000]	
Allowable load (when table is clamped)	$F \times L$ 	N·m [kgf·m]	490 [50]	833 [85]	1,764 [180]	2,450 [250]	4,410 [450]	
	$F \times L$ 	N·m [kgf·m]	931 [95]	1,568 [160]	2,450 [250]	3,430 [350]	7,840 [800]	
Allowable work inertia		$J = \frac{W \cdot D^2}{8}$  kg·m ² [kgf·cm·sec ²]	1.2 [12.3]	3.7 [38.5]	9.7 [99.8]	18.2 [185.2]	49.6 [506.2]	

☞ Servo motors of other manufacturers **P.66**

* 1 The tolerance of the table T-slot width is applicable to four standard slots arranged crosswise.

* 2 For model RNCM-631, a big bore type is also available. (center bore: φ180H7)

Dimensions

Unit: mm

RNCM-251R

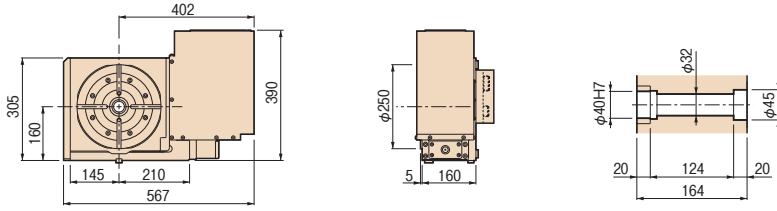

RNCM-301R

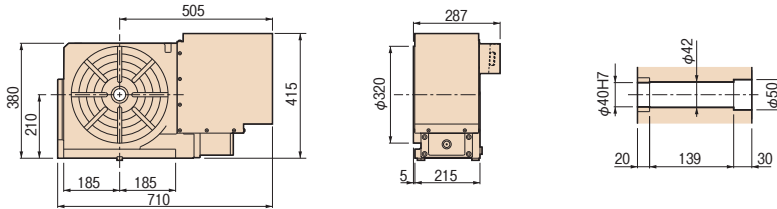

RNCM-401R

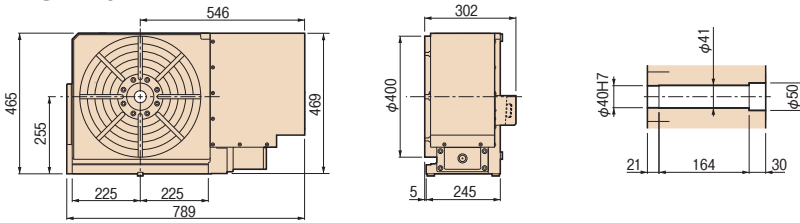

RNCM-501R

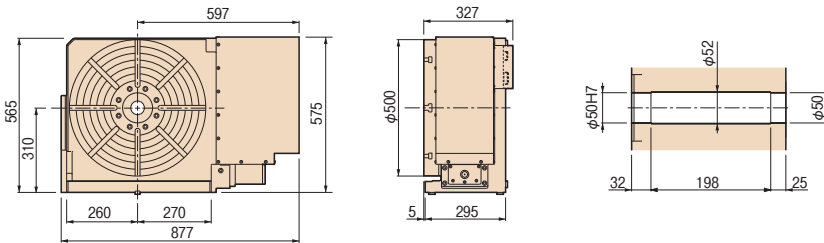

RNCM-631R

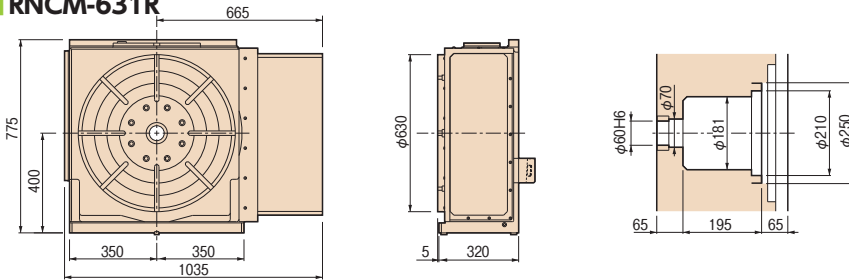

Note: The above dimensions are for FANUC servo motors. The dimensions of servo motors of other manufacturers may be larger.

Clamping block and bolt

Unit: mm

	Type	Q'ty	T-slot pitch	T-slot width	A	B	C	D	E	F	G	H	I	J	K	L	M
RNCM-251	I	4	50~125	18	25	12	80	12	33	35	22	21	11	65	40	28	16
RNCM-301	I	4	55~127	18	30	15	90	16	31	43	25	21	11	70	46	28	16
RNCM-401	I	4	55~155	18	30	15	90	16	31	43	25	21	11	70	46	28	16
RNCM-501	I	4	60~194	18	40	20	110	18	42	50	25	21	11	70	46	28	16
RNCM-631	II	4	90~255	18	40	18	63	18	15	30	58	21	11	105	60	28	16

Note: When using a machine with a T-slot pitch other than the above, use suitable clamping blocks and bolts that are available on the market, or order custom-made ones from TSUDAKOMA. (Option)

With Hydraulic Power Chuck
P.56



With Support Spindle and Fixture Plate
P.59



RBS

TBS

RWE/RWA
RN

RWE/RWA-B
RNCV-B

RNCM

RWB

RWB-K
RNCK

RCH
RNC

RCV
RNCV

Multi-Spindle
RWM

TWA/TN

TTNC

THNC

Multi-Spindle
TWM

RDS

RTV
RTT

RCB

NC Controllers

Accessories

Options

Technical Information

Type I

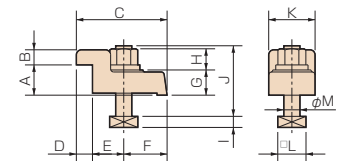

Type II

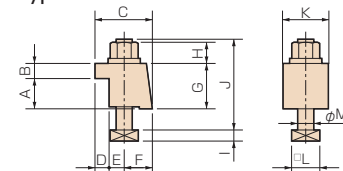

Standard type

RWB RWB-250·320·400·500









RWB-400R

Unit: mm

Our flagship models equipped with state-of-the-art TSUDAKOMA technology. It realizes stronger clamping torque and strength of worm gears than previous model. A larger through-bore size enables more ports number of rotary joint.

Specifications

RWB		RWB-250	RWB-320	RWB-400	RWB-500	
Handedness	R	○	○	○	○	
	L	○	○	○	○	
Table diameter		φ250	φ320	φ400	φ500	
Center height		160	210	255	310	
Center bore	Nose diameter	φ105	φ150	φ200	φ220	
	Through-bore	φ80	φ120	φ160	φ181	
Table T-slot width*1		12H7	14H7	14H7	18H7	
Guide block width		18h7	18h7	18h7	18h7	
Servo motors (for FANUC)		αiF8	αiF12	αiF12	αiF12	
Inertia converted into motor shaft × 10 ⁻³ kg·m ²		1.27	3.53	4.63	4.25	
Net weight kg		125	250	360	620	
Speed reduction ratio		1/90	1/120	1/120	1/180	
Table max. rpm min ⁻¹ (Motor rpm: 2,000min ⁻¹)		22.2	16.6	16.6	11.1	
Indexing accuracy (the sum) sec		14	14	14	14	
Clamp system		Hydraulic or air-hydraulic*2	Hydraulic or air-hydraulic*2	Hydraulic or air-hydraulic*2	Hydraulic or air-hydraulic*2	
Clamp torque /Hydraulic pressure 3.5Mpa N·m		1,300	3,100	5,500	7,600	
Strength of worm gears N·m		1,011	2,127	3,958	5,601	
NC Controllers	Vertical setting  kg	175	250	300	600	
	Allowable work weight	Vertical setting (with tailstock)	350	500	600	1,200
		Vertical setting (with SSB)	900	1,500	1,800	3,600
Accessories	Horizontal setting  kg	350	500	600	1,200	
	Allowable load (when table is clamped)	F  N	35,000	89,000	109,000	240,000
		F × L  N·m	1,300	3,100	5,500	7,600
F × L  N·m		1,500	5,300	7,800	17,000	
Options	Allowable work inertia $J = \frac{W \cdot D^2}{8}$  kg·m ²	7	19	36	112	
	Technical Information					

☞ Servo motors of other manufacturers **P.66**

* 1 The tolerance of the table T-slot width is applicable to four standard slots arranged crosswise. * 2 Option

For tables with a diameter of 800 or more, please order a big bore type of the following models:

Tables diameter	Model	Center bore	Specifications
φ 800	RCV-800	φ 360	P.26
φ 1000	RCV-1000	φ 410	P.26
φ 1250	RCV-1250	φ 500	P.26

Dimensions

Unit: mm

RWB-250R

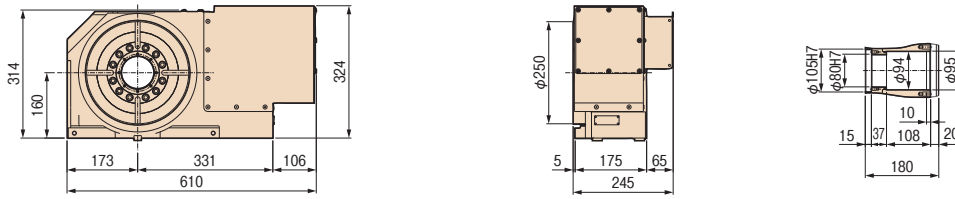

RWB-320R

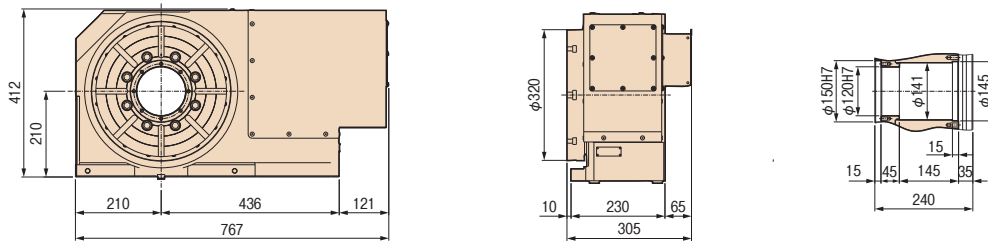

RWB-400R

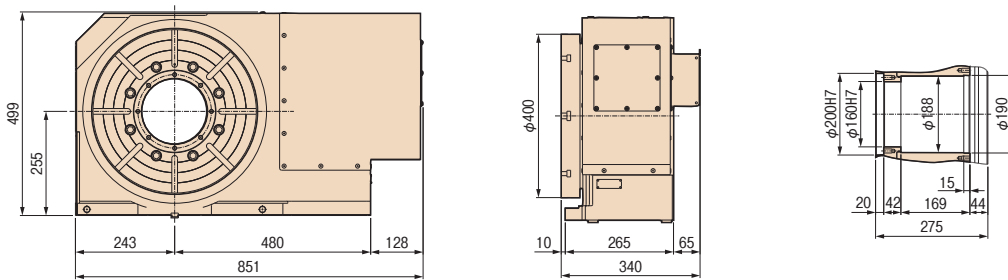

RWB-500R

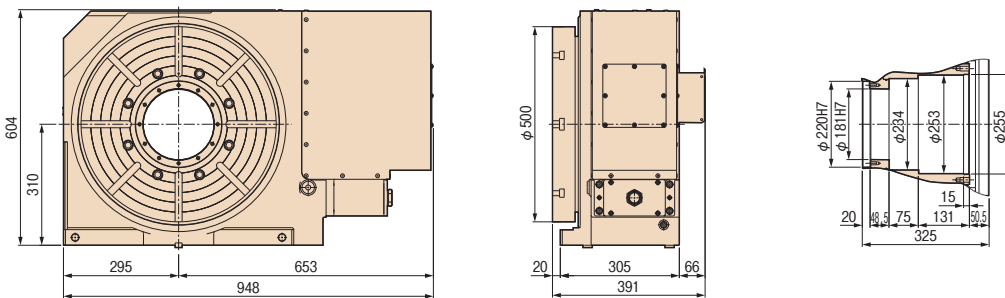

Note: The above dimensions are for FANUC servo motors. The dimensions of servo motors of other manufacturers may be larger.

RBS

TBS

RWE/RWA
RN

RWE/RWA-B
RNCV-B

RNCM

RWB

RWB-K
RNCK

RCH
RNC

RCV
RNCV

Multi-Spindle
RWM

TWA/TN

TTNC

THNC

Multi-Spindle
TWM

RDS

RTV
RTT

RCB

NC Controllers

Accessories

Options

Technical
Information

Clamping block and bolt

Unit: mm

	Type	Q'ty	T-slot pitch	T-slot width	A	B	C	D	E	F	G	H	I	J	K	L	M
RWB-250	I	4	50~125	18	25	12	80	12	33	35	22	21	11	65	40	28	16
RWB-320	I	4	73~162	18	30	15	90	16	31	43	25	21	11	70	46	28	16
RWB-400	I	4	73~193	18	30	15	90	16	31	43	25	21	11	70	46	28	16
RWB-500	I	4	73~233	18	40	20	110	18	42	50	25	21	11	70	46	28	16

Note: When using a machine with a T-slot pitch other than the above, use suitable clamping blocks and bolts that are available on the market, or order custom-made ones from TSUDAKOMA. (Option)

Type I

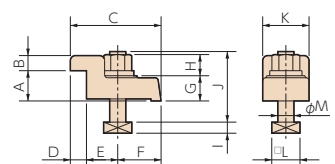

For horizontal machining centers

RWB-K

RWB-250K • 320K • 400K • 500K

RNCK

RNCK-631



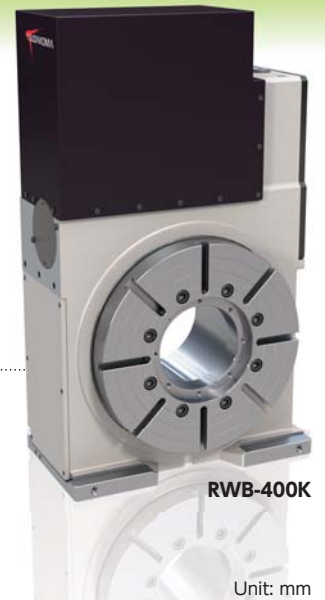

Flagship model with highest-class specifications exclusively for horizontal machining centers. A popular for the aircraft, automobile and cutting tool industries. A larger through-bore size enables more ports number of rotary joint than previous model.



RWB-400K

Unit: mm

Specifications

		RWB-250K	RWB-320K	RWB-400K	RWB-500K	RNCK-631	
Table diameter		φ 250	φ 320	φ 400	φ 500	φ 630	
Center height		160	210	255	310	400	
Center bore	Nose diameter	φ 105	φ 150	φ 200	φ 220	φ 60H6	
	Through-bore	φ 80	φ 120	φ 160	φ 182	φ 60	
Table T-slot width *1		12H7	14H7	14H7	18H7	18H7	
Guide block width		18h7	18h7	18h7	18h7	18h7	
Servo motors (for FANUC)		α iF8	α iF12	α iF12	α iF12	α iF12	
Inertia converted into motor shaft	× 10 ⁻³ kg·m ²	1.27	3.53	4.63	4.25	5.55	
Net weight	kg	130	250	370	590	800	
Speed reduction ratio		1/90	1/120	1/120	1/180	1/180	
Table max. rpm	min ⁻¹ (Motor rpm: 2,000min ⁻¹)	22.2	16.6	16.1	11.1	11.1	
Indexing accuracy (the sum)	sec	14	14	14	14	15	
Clamp system		Hydraulic or air-hydraulic*2	Hydraulic or air-hydraulic*2	Hydraulic or air-hydraulic*2	Hydraulic or air-hydraulic*2	Hydraulic or air-hydraulic*2	
Clamp torque /Hydraulic pressure 3.5Mpa	N·m	1,300	3,100	5,500	7,600	4,410	
Strength of worm gears	N·m	1,011	2,127	3,958	5,601	4,116	
Allowable work weight	Vertical setting 	kg	175	250	300	600	400
	Vertical setting (with tailstock)		350	500	600	1,200	800
	Vertical setting (with SSB)		900	1,500	1,800	3,600	—
Allowable load (when table is clamped)	F 	N	35,000	89,000	109,000	240,000	49,000
	F × L 	N·m	1,300	3,100	5,500	7,600	4,410
	F × L 	N·m	1,500	5,300	7,800	17,000	7,840
Allowable work inertia	$J = \frac{W \cdot D^2}{8}$ 	kg·m ²	7	19	36	112	49.6

 Servo motors of other manufacturers **P.66**

* 1 The tolerance of the table T-slot width is applicable to four standard slots arranged crosswise. * 2 Option
For tables with a diameter of 800 or more, please order a big bore type of the following models:

Tables diameter	Model	Center bore	Specifications
φ 800	RCV-800 (Upper class motor)	φ 360	P.26
φ 1000	RCV-1000 (Upper class motor)	φ 410	P.26
φ 1250	RCV-1250 (Upper class motor)	φ 500	P.26

Note: For the RNCK-631, a basic model (for vertical machining centers) is also available. (for standard bore)

Dimensions

Unit: mm

RWB-250K

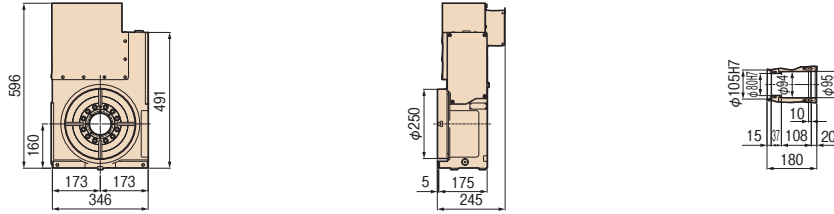

RWB-320K

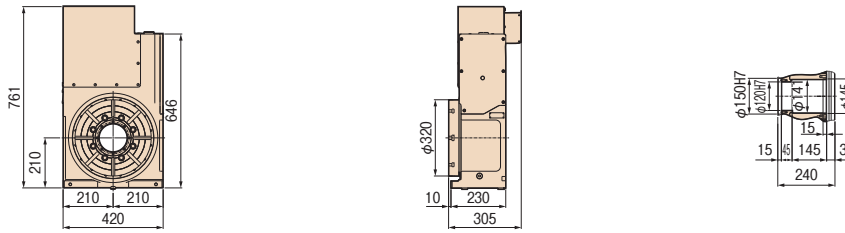

RWB-400K

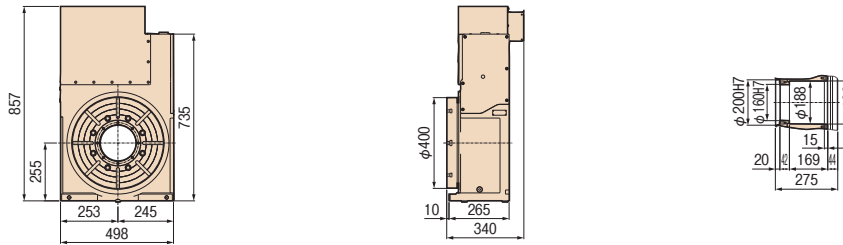

RWB-500K

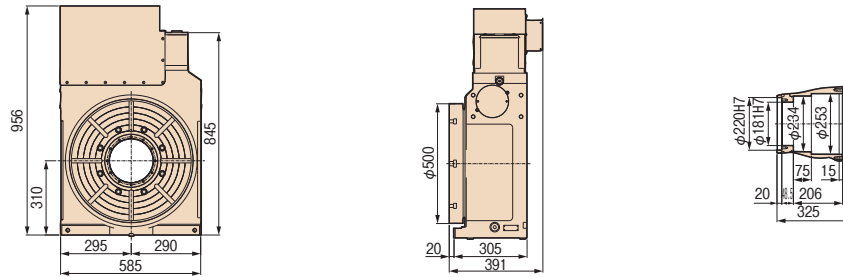

RNCK-631

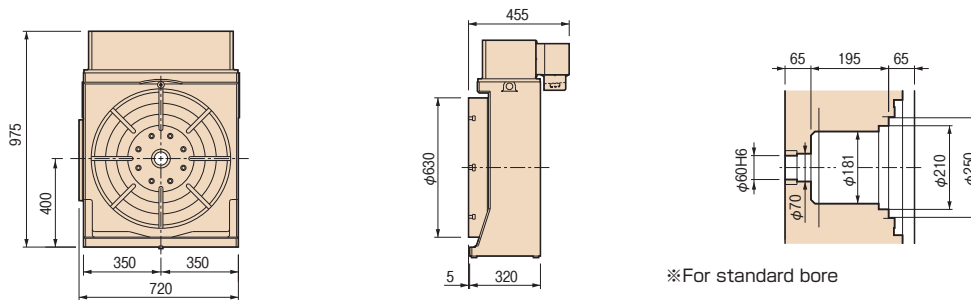

※For standard bore

Clamping block and bolt

	Type	Q'ty	T-slot pitch	T-slot width	A	B	C	D	E	F	G	H	I	J	K	L	M
RWB-250K	I	4	50~125	18	25	12	80	12	33	35	22	21	11	65	40	28	16
RWB-320K	I	4	73~162	18	30	15	90	16	31	43	25	21	11	70	46	28	16
RWB-400K	I	4	73~160	18	30	15	90	16	31	43	25	21	11	70	46	28	16
RWB-500K	I	4	73~200	18	40	20	110	18	42	50	25	21	11	70	46	28	16
RNCK-631	II	4	100~255	18	40	18	63	18	15	30	58	21	11	105	60	28	16

Note: When using a machine with a T-slot pitch other than the above, use suitable clamping blocks and bolts that are available on the market, or order custom-made ones from TSUDAKOMA. (Option)

Type I

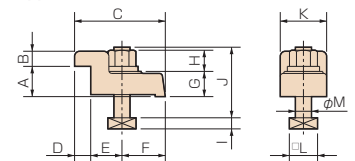

Type II

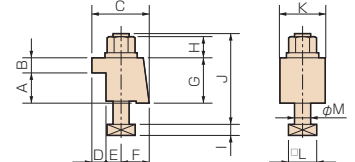

RBS

TBS

RWE/RWA
RN

RWE/RWA-B
RNCV-B

RNCM

RWB

**RWB-K
RNCK**

RCH

RNC

RCV
RNCV

Multi-Spindle
RWM

TWA/TN

TTNC

THNC

Multi-Spindle
TWM

RDS

RTV

RTT

RCB

NC Controllers

Accessories

Options

Technical
Information

For horizontal setting

RCH RCH-800•1000•1250

RNC RNC-1501•2001

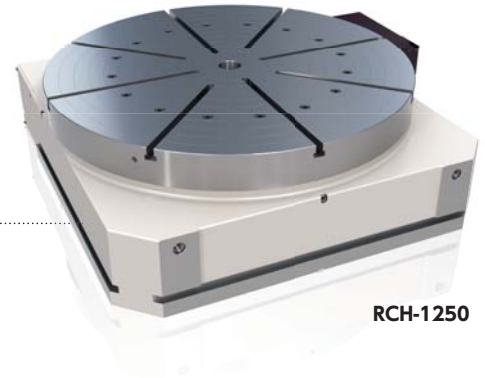





RCH-1250

Horizontal large-capacity model with high rigidity is good for machining heavy workpieces with large size double column and 5-face M/C.

Specifications

Unit: mm

		RCH-800	RCH-1000	RCH-1250	RNC-1501	RNC-2001
RCH RNC	Table diameter ():option	φ 800 (φ 1,000)	φ 1,000 (φ 1,200)	φ 1,250 (φ 1,500)	φ 1,500	φ 2,000
	Table height	320	330	410	400	620
RCV RNCV	Center bore Nose diameter	φ 75H7×30	φ 75H7×30	φ 75H7×30	φ 75H7	φ 225H7
Multi-Spindle RWM	Table T-slot width *1	18H7	22H7	22H7	28H7	28H7
	Guide block width	22h7	22h7	22h7	—	—
	Servo motors (for FANUC)	α iF12	α iF22	α iF22	α iF22	α iF30
TWA/TN	Inertia converted into motor shaft $\times 10^{-3} \text{kg} \cdot \text{m}^2$ [$\times 10^{-3} \text{kgf} \cdot \text{cm} \cdot \text{sec}^2$]	4.72 [48.2]	8.24 [84.1]	5.04 [51.4]	5.6 [56.6]	17.2 [175.3]
TTNC	Net weight kg	1,150	1,700	3,100	3,600	8,000
THNC	Speed reduction ratio	1/360	1/360	1/720	1/720	1/720
Multi-Spindle TWM	Table max. rpm min^{-1} (Motor rpm: 2,000 min^{-1})	5.5	5.5	2.7	2.7	2.7
	Indexing accuracy (the sum) sec	15	15	15	15	15
RDS	Clamp system	Hydraulic or air-hydraulic*2	Hydraulic or air-hydraulic*2	Hydraulic or air-hydraulic*2	Hydraulic or air-hydraulic*2	Hydraulic or air-hydraulic*2
RTV RTT	Clamp torque $\text{N} \cdot \text{m}$ /Hydraulic pressure 3.5Mpa [35kgf/cm ²] [kgf·m]	7,000 [714]	20,000 [2,040]	33,000 [3,363]	9,800 [1,000]	19,600 [2,000]
RCB	Strength of worm gears $\text{N} \cdot \text{m}$ [kgf·m]	7,840 [800]	13,230 [1,350]	25,000 [2,548]	21,560 [2,200]	49,000 [5,000]
NC Controllers	Allowable work weight Horizontal setting  kg	4,000	7,000	14,000	8,000	10,000
Accessories	F  N [kgf]	100,000 [10,204]	185,000 [18,878]	383,000 [39,041]	49,000 [5,000]	58,800 [6,000]
Options	F × L  $\text{N} \cdot \text{m}$ [kgf·m]	7,000 [714]	20,000 [2,040]	33,000 [3,363]	9,800 [1,000]	19,600 [2,000]
Technical Information	F × L  $\text{N} \cdot \text{m}$ [kgf·m]	11,600 [1,184]	22,900 [2,337]	56,700 [5,779]	24,500 [2,500]	34,300 [3,500]
	Allowable work inertia $J = \frac{W \cdot D^2}{8}$  $\text{kg} \cdot \text{m}^2$ [kgf·cm·sec ²]	320 [3,265]	874 [8,918]	2,734 [27,886]	2,255 [23,000]	4,900 [50,000]

☞ Servo motors of other manufacturers **P.66**

* 1 The tolerance of the table T-slot width is applicable to four standard slots arranged crosswise.

* 2 Option

Dimensions

Unit: mm

RCH-800

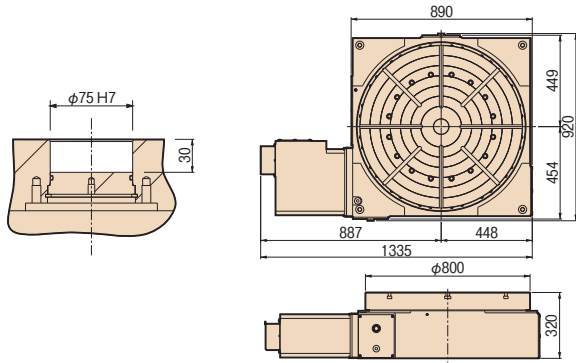

RCH-1000

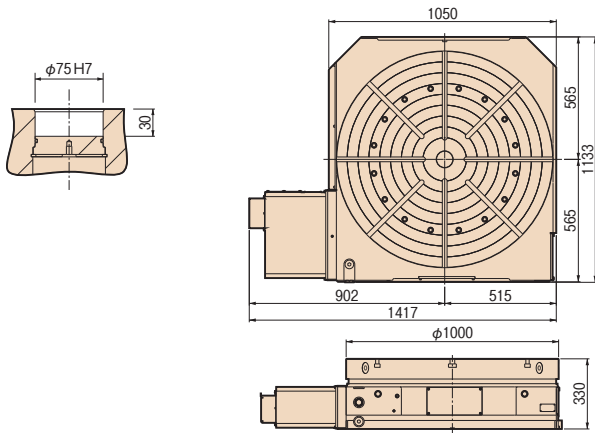

RCH-1250

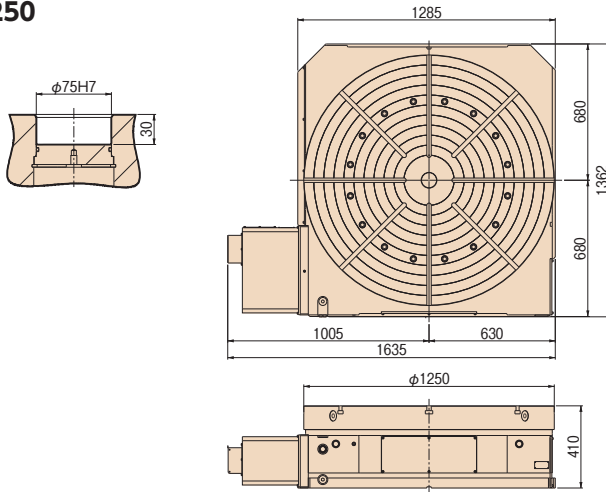

Note: The above dimensions are for FANUC servo motors. The dimensions of servo motors of other manufacturers may be larger.

Clamping block and bolt

Unit: mm

	Type	Q'ty	T-slot pitch	T-slot width	A	B	C	D	E	F	G	H	I	J	K	L	M
RCH-800	II	4	80~400	22	40	20	85	24	20	41	60	27	13	115	80	32	20
RCH-1000	II	4~8	80~320	22	40	20	85	24	20	41	60	27	13	115	80	32	20
RCH-1250	II	4~8	80~450	22	50	20	74	20	18	36	70	27	13	130	70	32	20
RNC-1501	IV	4~8	80~255	28	50	20	74	20	18	36	77	15	17.5	120	70	41.3	24

Note: When using a machine with a T-slot pitch other than the above, use suitable clamping blocks and bolts that are available on the market, or order custom-made ones from TSUDAKOMA. (Option)

RNC-2001

Large NC rotary table with a diameter of 2,000mm. Used for the position detecting device for controlling the posture of artificial satellites and other devices. Indexing accuracy: ±3 sec. Minimal angular indication: 0.5 sec

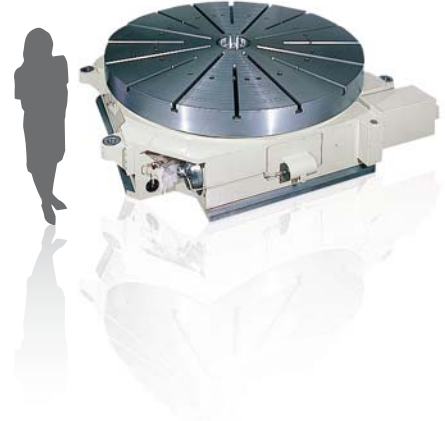

RBS

TBS

RWE/RWA
RN

RWE/RWA-B
RNCV-B

RNCM

RWB

RWB-K
RNCK

RCH
RNC

RCV
RNCV

Multi-Spindle
RWM

TWA/TN

TTNC

THNC

Multi-Spindle
TWM

RDS

RTV
RTT

RCB

NC Controllers

Accessories

Options

Technical
Information

Type II

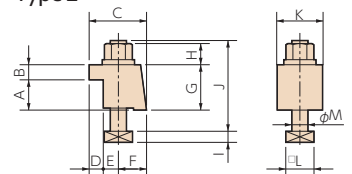

Type IV

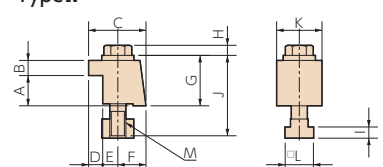

Horizontal motor mounting type

RCV RCV-800•1000•1250

RNCV RNCV-1501



RCV-1250R

Unit: mm

Standard model with the motor mounted horizontally onto the side of the body. A powerful hydraulic clamping mechanism is also equipped with this model.

Specifications

		RCV-800	RCV-1000	RCV-1250	RNCV-1501
Handedness	R	○	○	○	—
	L	—	—	—	○
	K	○	○	○	—
Table diameter () : option		φ 800 (φ 1,000)	φ 1,000 (φ 1,200)	φ 1,250 (φ 1,500)	φ 1,500
Center height		530	625	775	950
Center bore	Nose diameter	φ 360H7×45	φ 410H7×75	φ 500H7×25	φ 75H7
	Through-bore	φ 310	φ 360	φ 450	—
Table T-slot width *1		18H7	22H7	22H7	28H7
Guide block width		22h7	22h7	22h7	28h7
Servo motors (for FANUC)		α iF12	α iF22	α iF22	α iF22
Inertia converted into motor shaft × 10 ⁻³ kg·m ² [× 10 ⁻³ kgf·cm·sec ²]		4.89 [49.9]	8.24 [84.1]	5.04 [51.4]	12.8 [130.2]
Net weight		1,350	2,500	4,200	7,000
Speed reduction ratio		1/360	1/360	1/720	1/720
Table max. rpm (Motor rpm: 2,000min ⁻¹)		5.5	5.5	2.7	2.7
Indexing accuracy (the sum)		15	15	15	15
Clamp system		Hydraulic or air-hydraulic*2	Hydraulic	Hydraulic	Hydraulic or air-hydraulic*2
Clamp torque / Hydraulic pressure 3.5Mpa [35kgf/cm ²]		N·m [kgf·m] 7,000 [714]	20,000 [2,040]	33,000 [3,363]	17,650 [1,800]
Strength of worm gears		N·m [kgf·m] 7,840 [800]	13,230 [1,350]	25,000 [2,548]	21,560 [2,200]
Allowable work weight	Vertical setting () : with tailstock	kg 2,000 (4,000)	3,500 (7,000)	7,000 (14,000)	2,000 (5,000)
	Horizontal setting	kg 4,000	7,000	14,000	5,000
Allowable load (when table is clamped)	F	N [kgf] 100,000 [10,204]	185,000 [18,878]	383,000 [39,041]	58,800 [6,000]
	F × L	N·m [kgf·m] 7,000 [714]	20,000 [2,040]	33,000 [3,363]	17,650 [1,800]
	F × L	N·m [kgf·m] 11,600 [1,184]	22,900 [2,337]	56,700 [5,779]	19,600 [2,000]
Allowable work inertia	$J = \frac{W \cdot D^2}{8}$	kg·m ² [kgf·cm·sec ²] 320 [3,265]	874 [8,918]	2,734 [27,886]	2,255 [23,000]

☞ Servo motors of other manufacturers **P.66**

* 1 The tolerance of the table T-slot width is applicable to four standard slots arranged crosswise.

* 2 Option

Dimensions

Unit: mm

RCV-800R

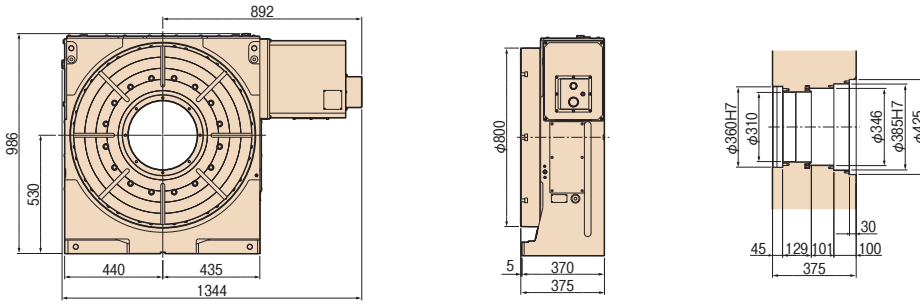

RCV-1000R

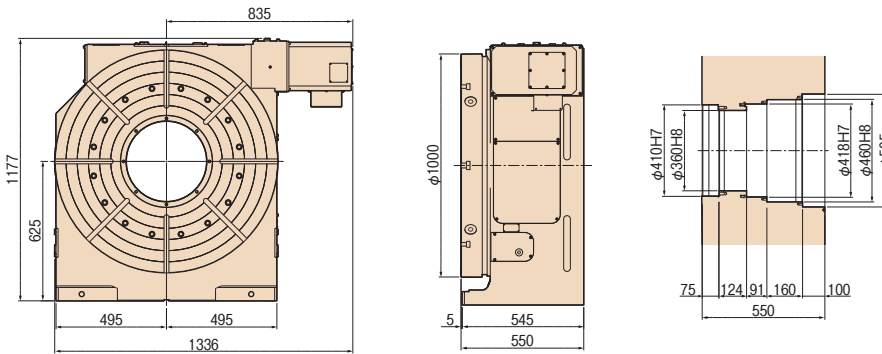

RCV-1250R

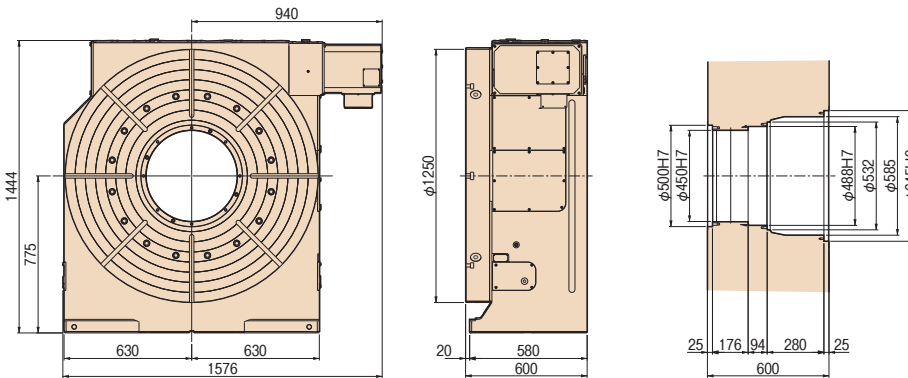

RTV-902

Largest Vertical NC Rotary Table
 Table diameter : ϕ 2,000 mm
 Allowable work weight : 30 t
 (with support spindle)
 Indexing accuracy : 15 sec
 Available up to ϕ 3,000 mm



- RBS
- TBS
- RWE/RWA
RN
- RWE/RWA-B
RNCV-B
- RNCM
- RWB
- RWB-K
RNCK
- RCH
RNC
- RCV
RNCV**
- Multi-Spindle
RWM
- TWA/TN
- TTNC
- THNC
- Multi-Spindle
TWM
- RDS
- RTV
RTT
- RCB
- NC Controllers
- Accessories
- Options
- Technical Information

Note: The above dimensions are for FANUC servo motors. The dimensions of servo motors of other manufacturers may be larger.

Clamping block and bolt

Unit: mm

	Type	Q'ty	T-slot pitch	T-slot width	A	B	C	D	E	F	G	H	I	J	K	L	M
RCV-800	II	4	100~250	22	60	28	95	29	16	50	88	27	13	145	100	32	20
RCV-1000	II	4	80~320	22	60	28	95	29	16	50	88	27	13	145	100	32	20
RCV-1250	II	8	80~450	22	60	28	95	29	16	50	88	27	13	145	100	32	20
RNCV-1501	IV	8	150~600	28	70	35	95	29	16	50	112	15	17.5	160	100	41.3	24

Note: When using a machine with a T-slot pitch other than the above, use suitable clamping blocks and bolts that are available on the market, or order custom-made ones from TSUDAKOMA. (Option)

Type II

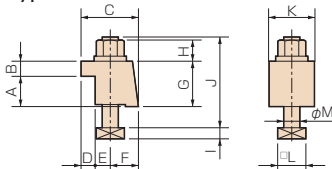

Type IV

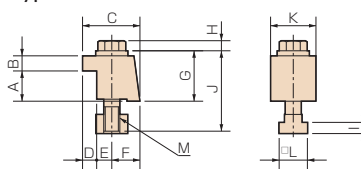

RWM

RWM-160-2/3/4 RWM-200-2/3/4





High-productivity model for multi-piece/multi-face machining. The RWM-160, the smallest of the RN-series, assures the fastest operation and meets the requirements for drilling and tapping machines.

Specifications



RWM-160R-2,PS

Unit: mm

		RWM-160			RWM-200		
Handedness	R	○			○		
	L	○			○		
Spindle diameter		φ 100h7			φ 120h7		
Table diameter		φ 160 (Option)			φ 200 (Option)		
Distance between spindles		215 or 250			250 or 320		
Center height		135			160		
Center bore	Nose diameter	φ 55H7			φ 65H7		
	Through-bore	φ 40			φ 45		
Guide block width		14h7			18h7		
Servo motors (for FANUC)		α iF4			α iF8		
Number of axis		2-axis	3-axis	4-axis	2-axis	3-axis	4-axis
Inertia converted into motor shaft (When spindle pitch is minimum) × 10 ⁻³ kg·m ²		0.31	0.43	0.56	0.46	0.64	0.85
Net weight (When spindle pitch is minimum and with base plate) kg		105	150	200	155	225	295
Speed reduction ratio		1/72			1/72		
Table max. rpm min ⁻¹ (Motor rpm: 3,000min ⁻¹)		41.6			41.6		
Clamp system		Pneumatic			Pneumatic		
Clamp torque ∕ pneumatic pressure 0.49MPa N·m		500			800		
Indexing accuracy (the sum) sec		25			20		
Strength of worm gears N·m		206			288		
Options	Allowable work weight Vertical setting  kg/axis () : with tailstock	100 (200)			125 (250)		
	F  N	10800			14400		
Technical Information	Allowable load (when table is clamped) F × L  N·m	500			800		
	F × L  N·m	780			1900		
Allowable work inertia (per single-axis) $J = \frac{W \cdot D^2}{8}$  kg·m ²		0.64			1.25		

 Servo motors of other manufacturers **P.66**

Dimensions

Unit: mm

RWM-160R-2/3/4,PS

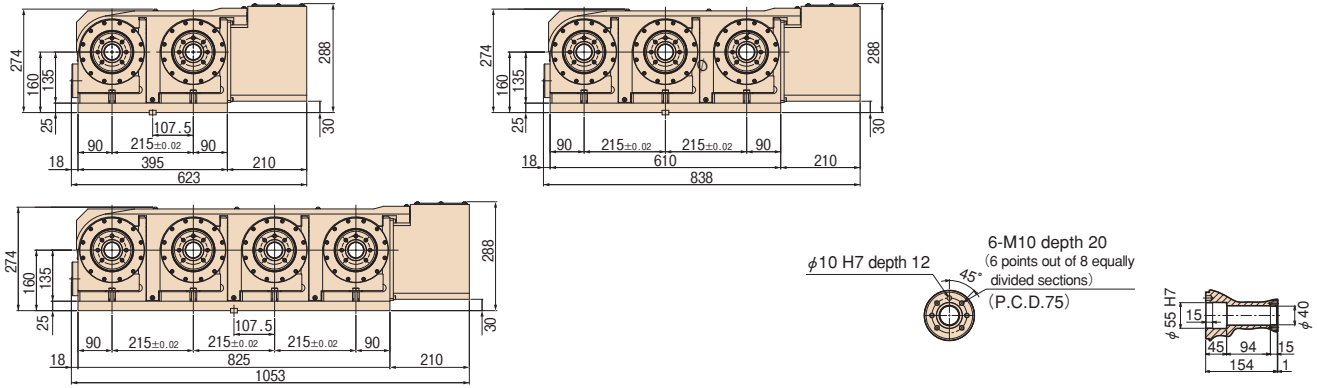

RWM-160R-2/3/4,PL

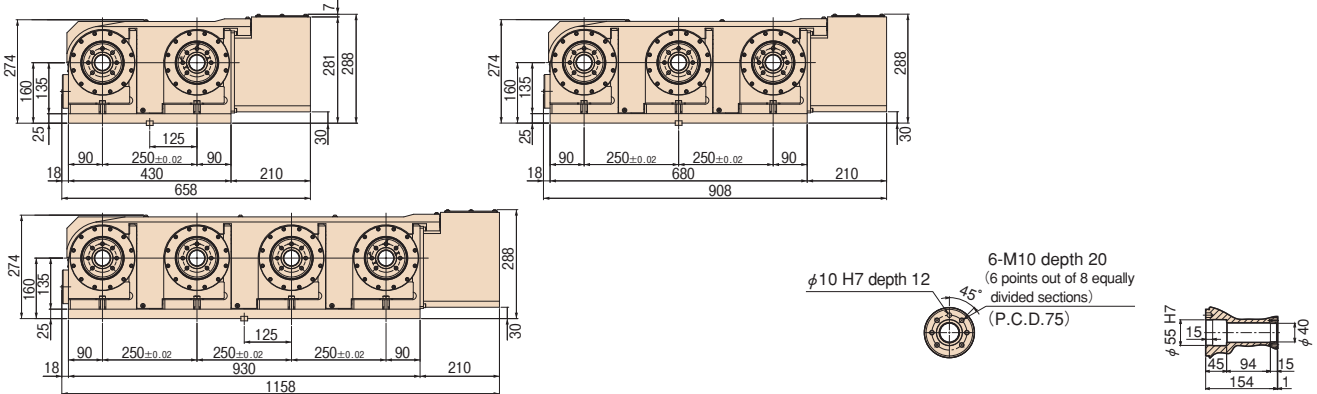

RWM-200R-2/3/4,PS

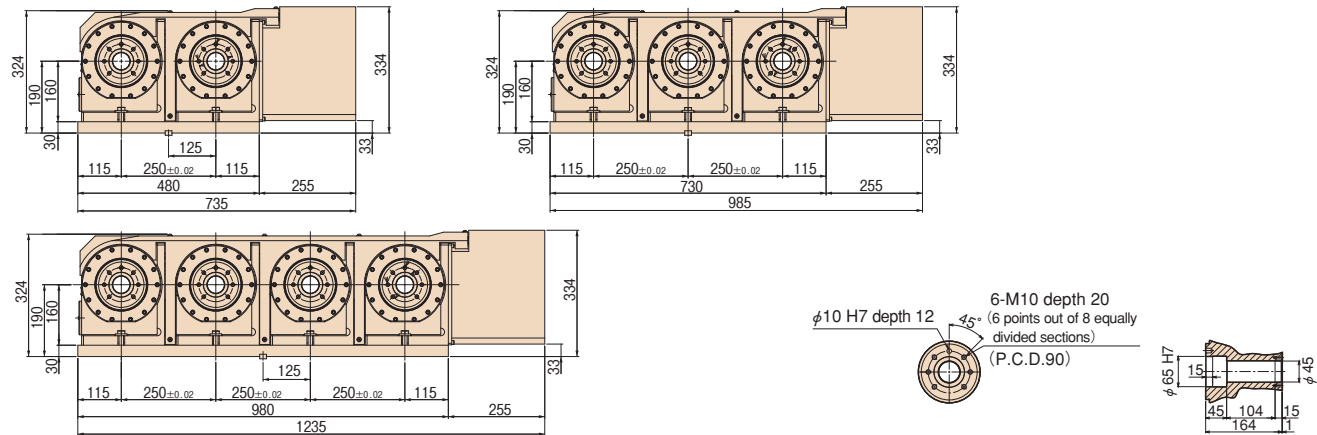

RWM-200R-2/3/4,PL

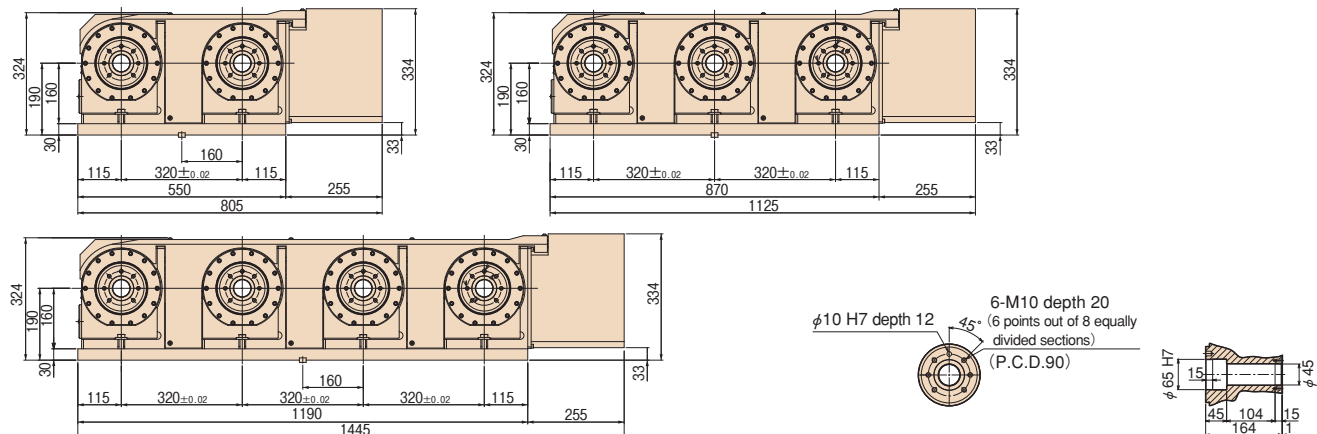

Note: The above dimensions are for FANUC servo motors. The dimensions of servo motors of other manufacturers may be larger.

RBS

TBS

RWE/RWA
RN

RWE/RWA-B
RNCV-B

RNCM

RWB

RWB-K
RNCK

RCH
RNC

RCV
RNCV

Multi-Spindle
RWM

TWA/TN

TTNC

THNC

Multi-Spindle
TWM

RDS

RTV
RTT

RCB

NC Controllers

Accessories

Options

Technical
Information

Standard type

TWA/TN

TWA-100•130•160•200 TN-320•450

Compact tables for speedy and powerful five-axis machining. TWA-100 and TWA-130 are the most suitable models for drilling and tapping machines.



TWA-130

Specifications

Unit: mm

		TWA-100	TWA-130	TWA-160	TWA-200	TN-320	TN-450
Tilt range		-17° ~ +107°	-17° ~ +107°	-30° ~ +110°	-30° ~ +110°	-30° ~ +110°	-10° ~ +95°
Spindle diameter		φ86h7	φ90h7	φ100h7	φ120h7	—	—
Table diameter*1		φ135 (Option)	φ135 (Option)	φ160 or 200 (Option)	φ200 or 250 (Option)	φ320	φ450
Table height at 0° position		180 (205 W/face plate)	210 (235 W/face plate)	235 (260 W/face plate)	270 (300 W/face plate)	355	425
Center height at 90° position		135	150	180	210	255	425
Center bore	Nose diameter	φ55H7 (φ40H7 W/face plate)	φ55H7 (φ40H7 W/face plate)	φ55H7 (φ50H7 W/face plate)	φ65H7 (φ60H7 W/face plate)	φ105H7	φ170H7
	Through-bore	φ35	φ37	φ40	φ45	φ102	φ136
Table T-slot width *1		12H8 (W/face plate)	12H8 (W/face plate)	12H8 (W/face plate)	12H8 (W/face plate)	14H7	14H7
Guide block width		14 h 7	14 h 7	18 h 7	18 h 7	18 h 7	18 h 7
Servo motors (for FANUC)	Rotary axis	αiS2	αiS2	αiS2	αiS2	αiF4	αiF4
	Tilt axis	αiS2	αiS2	αiS2	αiS2	αiF8	αiF8
Inertia converted into motor shaft	×10 ⁻³ kg·m ²	0.072	0.078	0.074	0.072	0.17	0.18
Speed reduction ratio		1/60	1/120	1/60	1/120	1/72	1/120
Table max. rpm	min ⁻¹ (Motor rpm: 2,000min ⁻¹)	41.6 (Motor rpm: 2,500min ⁻¹)	16.6	41.6 (Motor rpm: 2,500min ⁻¹)	16.6	27.7	16.6
Clamp system	Supplied pressure	Pneumatic 0.49MPa [5kgf/cm ²]	Pneumatic 0.49MPa [5kgf/cm ²]	Pneumatic 0.49MPa [5kgf/cm ²]	Pneumatic 0.49MPa [5kgf/cm ²]	Pneumatic 0.49MPa [5kgf/cm ²]	Pneumatic 0.49MPa [5kgf/cm ²]
	Clamp torque	N·m	200	300	500	500	500
Indexing accuracy (the sum)	arc sec	40	—	40	—	30	—
	Tilt 0° ~ 90° arc sec	—	45	—	45	—	45
Net weight	kg	75	85	135	195	440	1,200
	Strength of worm gears (Rotary axis)	N·m	152	152	200	450	931
Allowable work weight	0° (Horizontal)	kg	35	35	60	120	150
	0° ~ 90° (Tilting)	kg	20	20	40	70	100
Allowable work moment	W×L	N·m	24	24	39.2	53.7	163.3
	F	N	3,920	3,920	7,840	13,720	19,600
Allowable load (when table is clamped)	F×L	N·m	200	500	500	800	2,200
	F×L	N·m	300	500	800	1,000	2,200
Allowable work inertia	$J = \frac{W \cdot D^2}{8}$	kg·m ²	0.08	0.08	0.19	0.59	1.53

☞ Servo motors of other manufacturers **P.66** ☞ When assembling a faceplate or a fixture with the main spindle **P.76**

* 1 The tolerance of the table T-slot width is applicable to four standard slots arranged crosswise. ☞ Dimensions **P.60**

Dimensions

Unit: mm

TWA-100

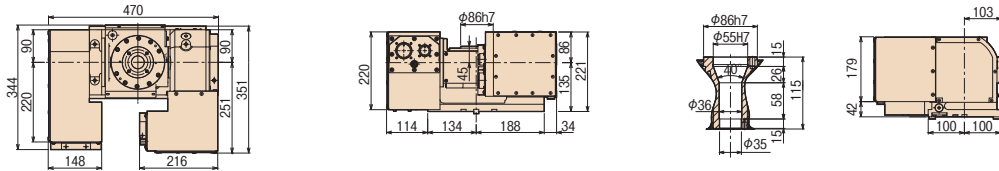

TWA-130

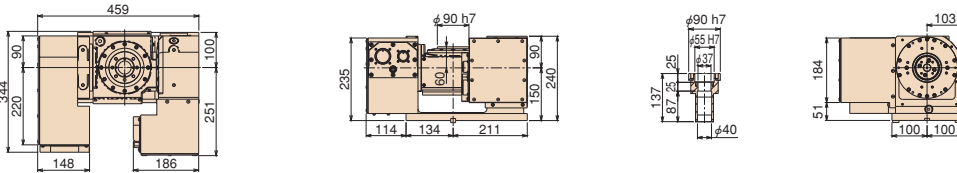

TWA-160

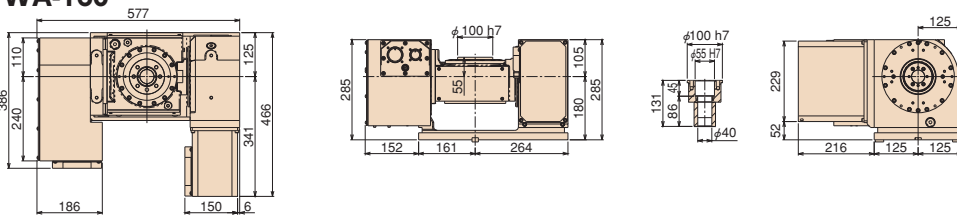

TWA-200

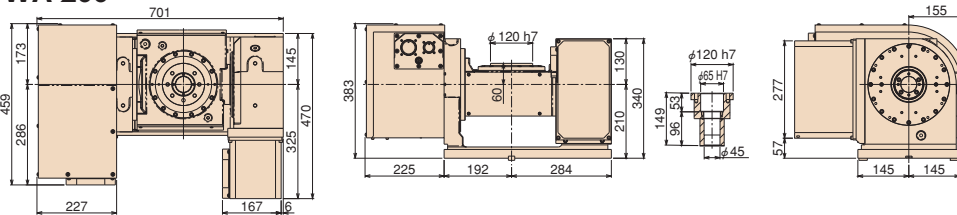

TN-320

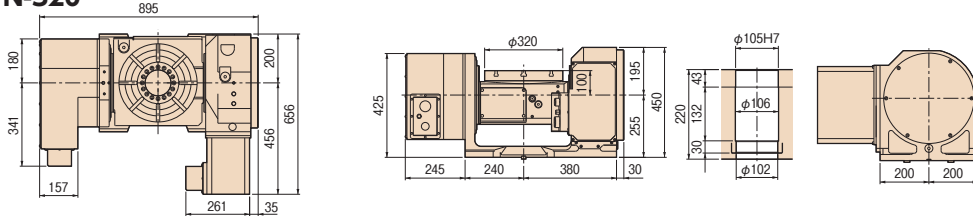

TN-450

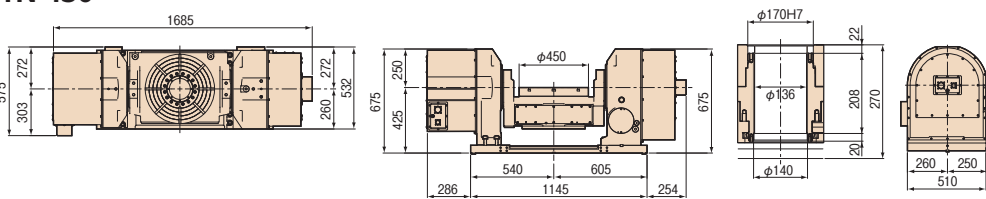

Layout a

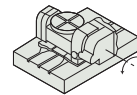

Layout b

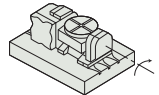

Type I

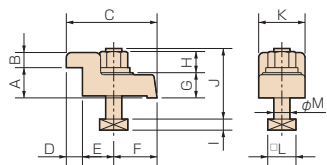

Type IV

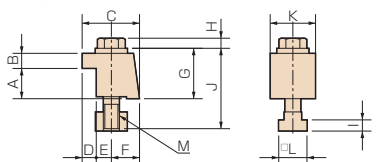

- RBS
- TBS
- RWE/RWA
RN
- RWE/RWA-B
RNCV-B
- RNCM
- RWB
- RWB-K
RNCK
- RCH
RNC
- RCV
RNCV
- Multi-Spindle
RWM
- TWA/TN
- TTNC
- THNC
- Multi-Spindle
TWM
- RDS
- RTV
RTT
- RCB

- NC Controllers
- Accessories
- Options
- Technical Information

Note: The above dimensions are for FANUC servo motors. The dimensions of servo motors of other manufacturers may be larger.

Clamping block and bolt

Unit: mm

	Type	Q'ty	Layout	T-slot pitch	T-slot width	A	B	C	D	E	F	G	H	I	J	K	L	M
TWA-100	I	4	a b	40~160 *	14	20	12	70	10	35	25	20	12	8	50	35	23	12
TWA-130	I	4	a b	40~190 *	14	20	12	70	10	35	25	20	17	8	55	35	23	12
TWA-160	I	4	a b	78~150 63~117	18	20	12	70	10	35	25	17	15	11	55	35	28	16
TWA-200	I	4	a b	80~180 78~125	18	25	12	80	12	33	35	22	21	11	65	40	28	16
TN-320	I	4	a b	140~190 95~180	18	25	12	80	12	33	35	22	21	11	65	40	28	16
TN-450	IV	4	a b	80~250 *	18	50	20	74	20	18	36	75	10	11	105	70	28	16

Note 1: * In the case of layout b, contact us for the details about mounting.

Note 2: When using a machine with a T-slot pitch other than the above, use suitable clamping blocks and bolts that are available on the market, or order custom-made ones from TSUDAKOMA. (Option)

Standard type

TTNC

TTNC-631•1001•1500

Large tilting models that enable 5-face machining and slanted-hole machining with single chucking of workpiece. Suitable for machining of component parts for heavy industries such as aircraft, power generator and construction machine industry.



TTNC-1500

Unit: mm

Specifications

	TTNC-631	TTNC-1001	TTNC-1500*2				
Tilt range	-10° ~ +95°	-20° ~ +110°	-5° ~ +95°				
Spindle diameter	—	—	—				
Table diameter	φ 630	φ 1,000	φ 1,500				
Table height at 0° position	585	900	1,155				
Center height at 90° position	450	700	1,055				
Center bore	Nose diameter	φ 180H6	φ 75H7				
	Through-bore	φ 180	—				
Table T-slot width*1	18H7	22H7	28H7				
Guide block width	18h7	—	—				
Servo motors (for FANUC)	Rotary axis	Tilt axis	Rotary axis	Tilt axis	Rotary axis	Tilt axis	
	α iF12	α iF12	α iF22	α iF30	TPC5-SR30	TPC5-SR30	
Inertia converted into motor shaft	$\times 10^{-3} \text{kg} \cdot \text{m}^2$	5.42	3.77	4.37	4.1	5.37	7.46
	$[\times 10^{-3} \text{kgf} \cdot \text{cm} \cdot \text{sec}^2]$	[55.3]	[38.5]	[44.6]	[41.8]	[54.8]	[76.2]
Speed reduction ratio	1/180	1/360	1/360	1/1,440	1/720	1/1,440	
Table max. rpm	min ⁻¹	11.1	4.1 (Motor rpm: 1,500min ⁻¹)	5.5	1.3	1.39 (Motor rpm: 1,000min ⁻¹)	0.7 (Motor rpm: 1,000min ⁻¹)
	(Motor rpm: 2,000min ⁻¹)						
Clamp system	Hydraulic	Hydraulic	Hydraulic	Hydraulic	Hydraulic	Hydraulic	
	3.5MPa	3.5MPa	6.9MPa	6.9MPa	3.5MPa	3.5MPa	
Supplied pressure	[35kgf/cm ²]	[35kgf/cm ²]	[70kgf/cm ²]	[70kgf/cm ²]	[35kgf/cm ²]	[35kgf/cm ²]	
Clamp torque	N·m	4,410	2,352	9,800	19,600	12,000	25,000
	[kgf·m]	[450]	[240]	[1,000]	[2,000]	[1,224]	[2,551]
Indexing accuracy (the sum)	arc sec	15	—	15	—	20	—
Tilting accuracy	Tilt 0° ~ 90°	—	60	—	60	—	45
	arc sec						
Net weight	kg	1,700	4,600	12,000			
Strength of worm gears (Rotary axis)	N·m [kgf·m]	3,284 [335]	13,230 [1,350]	21,560 [2,200]			
Options	Allowable work weight	0° (Horizontal)	kg	600	2,500	2,500	
		0° ~ 90° (Tilting)	kg	300	1,500	1,500	
Technical Information	Allowable work moment	W×L	N·m [kgf·m]	980 [100]	7,840 [800]	7,840 [800]	
	Allowable load (when table is clamped)	F	N [kgf]	24,500 [2,500]	29,400 [3,000]	49,000 [5,000]	
	Allowable load (when table is clamped)	F×L	N·m [kgf·m]	4,410 [450]	9,800 [1,000]	12,000 [1,224]	
	Allowable load (when table is clamped)	F×L	N·m [kgf·m]	2,352 [240]	19,600 [2,000]	25,000 [2,551]	
	Allowable work inertia	$J = \frac{W \cdot D^2}{8}$	kg·m ² [kgf·cm·sec ²]	35.3 [360]	312.6 [3,188.7]	2,255 [23,001]	

☞ Servo motors of other manufacturers **P.66**

* 1 The tolerance of the table T-slot width is applicable to four standard slots arranged crosswise.
 * 2 Above specifications are for one of experienced production. Those might be changed depending on use conditions.

Dimensions

Unit: mm

TTNC-631

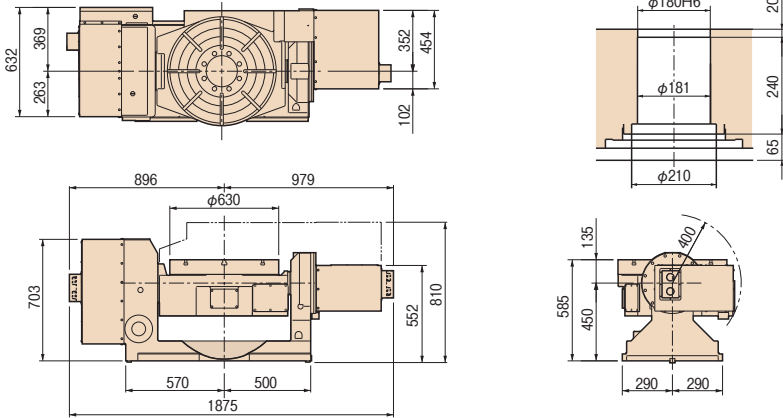

TTNC-1001

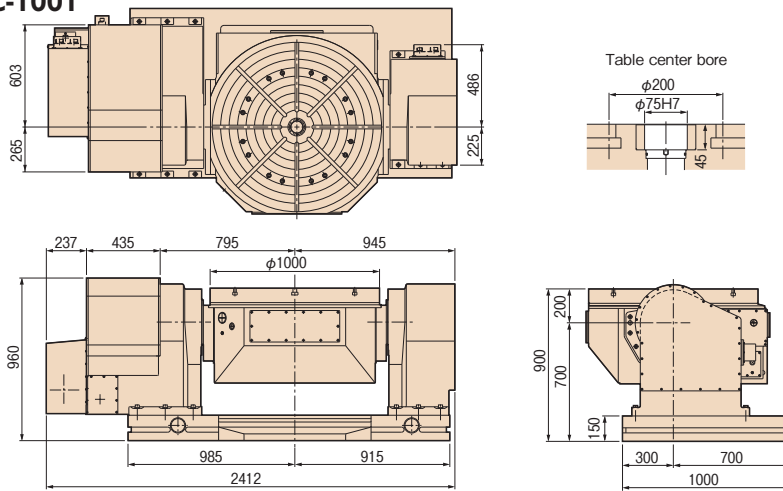

TTNC-1500

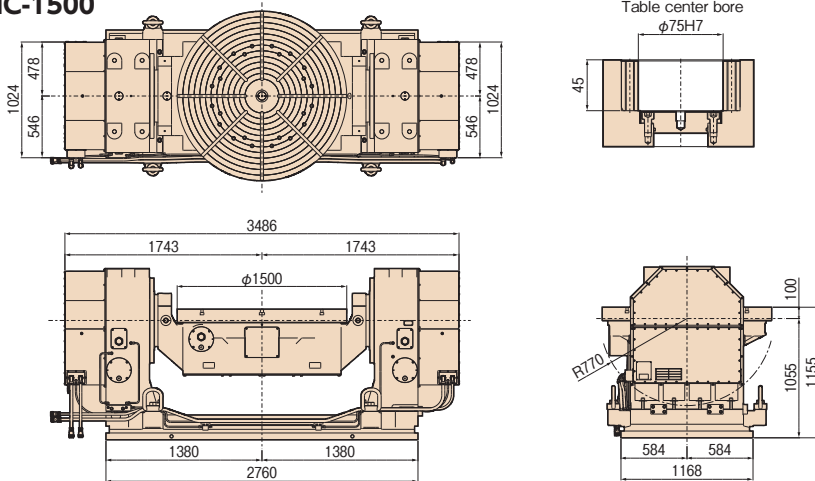

Note: The above dimensions are for FANUC servo motors. The dimensions of servo motors of other manufacturers may be larger.

Clamping block and bolt

Unit: mm

	Type	Q'ty	Layout	T-slot pitch	T-slot width	A	B	C	D	E	F	G	H	I	J	K	L	M
TTNC-631	I	4	a b	168~450 *	18	40	20	110	18	42	50	25	21	11	70	46	28	16
TTNC-1001	II	8	—	—	24	50	20	74	20	18	36	70	29	16	130	70	40	22
TTNC-1500	II	10	—	—	28	60	28	95	29	16	50	95	22	17.5	146	100	41.3	24

Note 1: * In the case of layout b, contact us for the details about mounting.

Note 2: When using a machine with a T-slot pitch other than the above, use suitable clamping blocks and bolts that are available on the market, or order custom-made ones from TSUDAKOMA. (Option)

Layout a

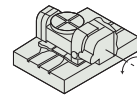

Layout b

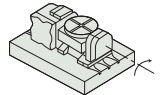

Type I

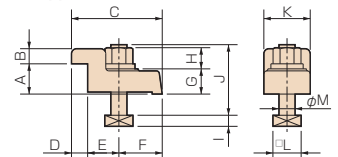

Type II

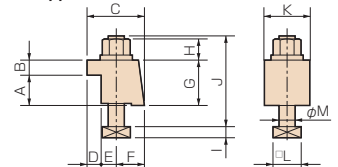

- RBS
- TBS
- RWE/RWA
RN
- RWE/RWA-B
RNCV-B
- RNCM
- RWB
- RWB-K
RNCK
- RCH
RNC
- RCV
RNCV
- Multi-Spindle
RWM
- TWA/TN
- TTNC
- THNC
- Multi-Spindle
TWM
- RDS
- RTV
RTT
- RCB
- NC Controllers
- Accessories
- Options
- Technical Information

Manual Tilting type

THNC THNC-251•301







THNC-251

Manual tilt adjustment type with a highly rigid body and a powerful hydraulic clamp system.

Specifications

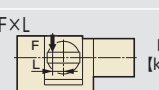
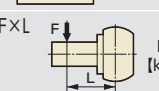
Unit: mm

		THNC-251		THNC-301	
Tilt range		0° ~ +93°		0° ~ +93°	
Table diameter*1		φ250		φ320	
Table height at 0° position		230		265	
Center height at 90° position		210		235	
Center bore	Nose diameter	φ40H7		φ40H7	
	Through-bore	φ32		φ40	
Table T-slot width*1		12H7		14H7	
Guide block width		18h7		18h7	
Servo motors (for FANUC)	Rotary axis	αiF4	Manual	αiF8	Manual
	Tilt axis				
Inertia converted into motor shaft	$\times 10^{-3} \text{kg} \cdot \text{m}^2$	0.20	—	0.25	—
	$[\times 10^{-3} \text{kgf} \cdot \text{cm} \cdot \text{sec}^2]$	[2.0]		[2.6]	
Speed reduction ratio		1/180	—	1/180	—
Table max. rpm	min ⁻¹	11.1	—	11.1	—
	(Motor rpm: 2,000min ⁻¹)				
Clamp system		Hydraulic	Manual	Hydraulic	Manual
Supplied pressure		3.5MPa [35kgf/cm ²]	19.6N·m [2kgf/m]	3.5MPa [35kgf/cm ²]	35.3N·m [3.6kgf/m]
Clamp torque	N·m [kgf·m]	490 [50]	490 [50]	833 [85]	1,862 [190]
Indexing accuracy(the sum)	sec	15	60	15	60
Net weight	kg	125		180	
Strength of worm gears (Rotary axis)	N·m [kgf·m]	470 [48]		764 [78]	
Allowable work weight	0° (Horizontal)	 kg	80	200	
	0° ~ 90° (Tilting)	 kg	40	100	
Allowable load	F	 N [kgf]	6,860 [700]	9,800 [1,000]	
Allowable load (when table is clamped)	FxL	 N·m [kgf·m]	490 [50]	833 [85]	
	FxL	 N·m [kgf·m]	490 [50]	1,862 [190]	
Allowable work inertia	$J = \frac{W \cdot D^2}{8}$	 kg·m ² [kgf·cm·sec ²]	0.62 [6.3]	2.25 [23]	

 Servo motors of other manufacturers **P.66**

* 1 The tolerance of the table T-slot width is applicable to four standard slots arranged crosswise.  Dimensions **P.60**

Dimensions

Unit: mm

THNC-251

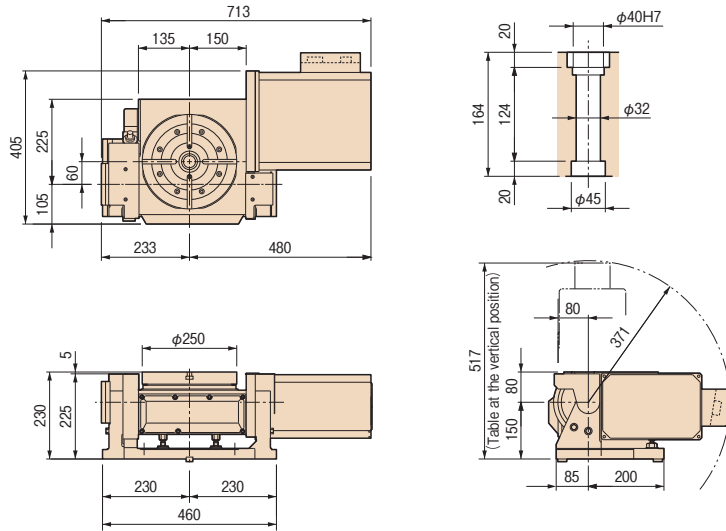

THNC-301

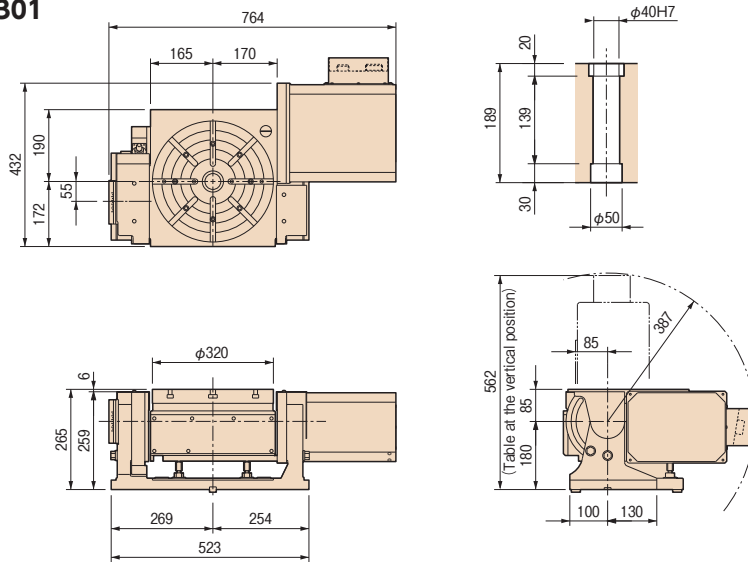

Note: The above dimensions are for FANUC servo motors. The dimensions of servo motors of other manufacturers may be larger.

- RBS
- TBS
- RWE/RWA
RN
- RWE/RWA-B
RNCV-B
- RNCM
- RWB
- RWB-K
RNCK
- RCH
RNC
- RCV
RNCV
- Multi-Spindle
RWM
- TWA/TN
- TTNC
- THNC**
- Multi-Spindle
TWM
- RDS
- RTV
RTT
- RCB
- NC Controllers
- Accessories
- Options
- Technical Information

Clamping block and bolt

Unit: mm

	Type	Q'ty	Layout	T-slot pitch	T-slot width	A	B	C	D	E	F	G	H	I	J	K	L	M
THNC-251	I	4	a b	40~100 40~65	18	25	12	80	12	33	35	22	21	11	65	40	28	16
THNC-301	II	4	a b	40~130 40~80	18	25	15	52	12	15	25	40	21	11	85	40	28	16

Note: When using a machine with a T-slot pitch other than the above, use suitable clamping blocks and bolts that are available on the market, or order custom-made ones from TSUDAKOMA. (Option)

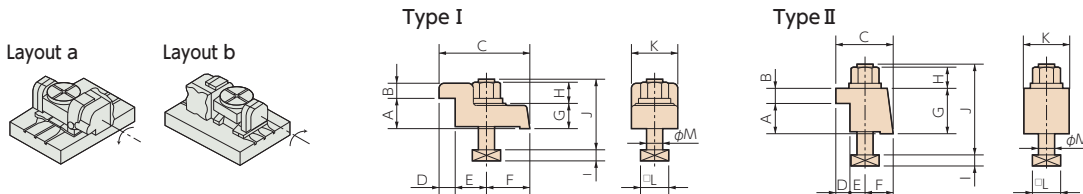

TWM

TWM-160·250

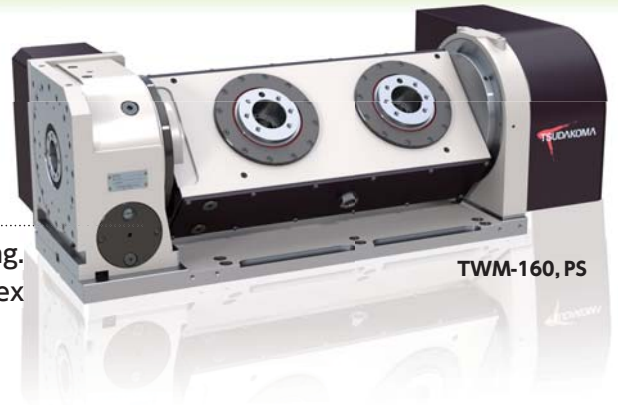

TWM-160, PS

Tilt type multi-spindle enables highly productive machining. Simultaneous machining of multiple workpieces with complex shapes and 5-face machining is possible.

Specifications

Unit: mm

		TWM-160		TWM-250	
Tilt range		-30° ~ +110°		-30° ~ +110°	
Spindle diameter		φ 100h7		φ 140h7	
Table diameter*1		φ 160 or φ 200 (Option)		φ 250 (Option)	
Distance between spindles		250 or 320		320 or 400	
Table height at 0° position		250 (280 W/face plate)		325 (355 W/face plate)	
Center height at 90° position		190		260	
Center bore	Nose diameter	φ 55H7		φ 80H7	
	Through-bore	φ 40		φ 50	
Guide block width		18h7		18h7	
Servo motors (for FANUC)		Rotary axis	Tilt axis	Rotary axis	Tilt axis
		α iF4	α iF8	α iF8	α iF12
Inertia converted into motor shaft × 10 ⁻³ kg·m ²		0.52	0.50	0.69	4.40
Speed reduction ratio		1/60	1/90	1/90	1/90
Table max. rpm		50	33.3	33.3	33.3
		min ⁻¹ (Motor rpm: 3,000min ⁻¹)			
Clamp system		Pneumatic	Pneumatic	Pneumatic	Hydraulic or air-hydraulic (Option)
Supplied pressure		0.49MPa	0.49MPa	0.49MPa	3.5MPa
Clamp torque N·m		500	1000	1000	3100
Indexing accuracy(the sum) arc sec		30	—	20	—
Tilting accuracy		Tilt 0° ~ 90° arc sec	—	60	60
		Tilt - 30° ~ 90° arc sec	—	75	75
Net weight kg		240		550	
Strength of worm gears (Rotary axis) N·m		200		596	
NC Controllers		0° (Horizontal) kg/axis		100	
Accessories		0° ~ 90° (Tilting) kg/axis		100	
Options					
Technical Information		W×L N·m		347.4	
		F N		10800	
Allowable load (when table is clamped)		F×L N·m		1000	
		F×L N·m		3100	
Allowable work inertia (per single-axis)		$J = \frac{W \cdot D^2}{8}$ kg·m ²		0.9	

Servo motors of other manufacturers **P.66**

Dimensions

Unit: mm

TWM-160,PS

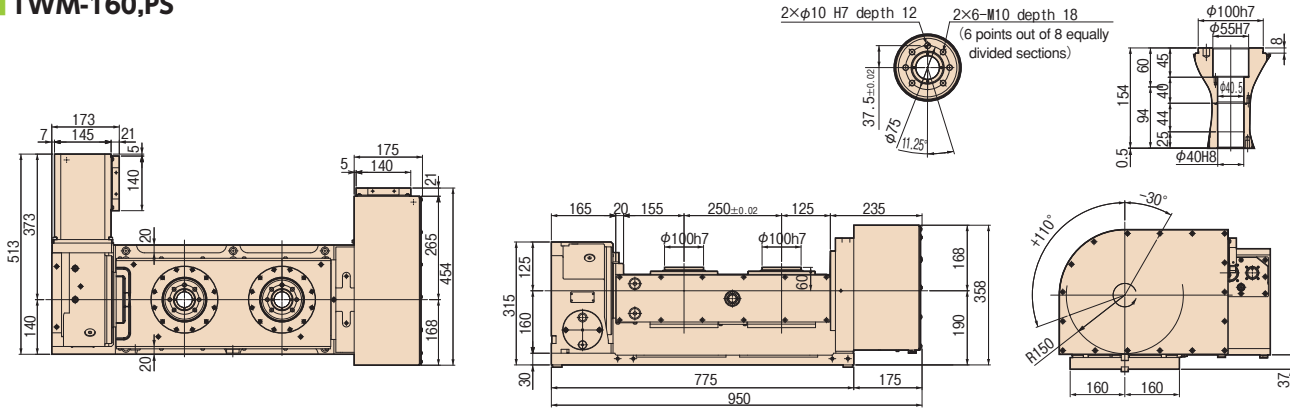

TWM-160,PL

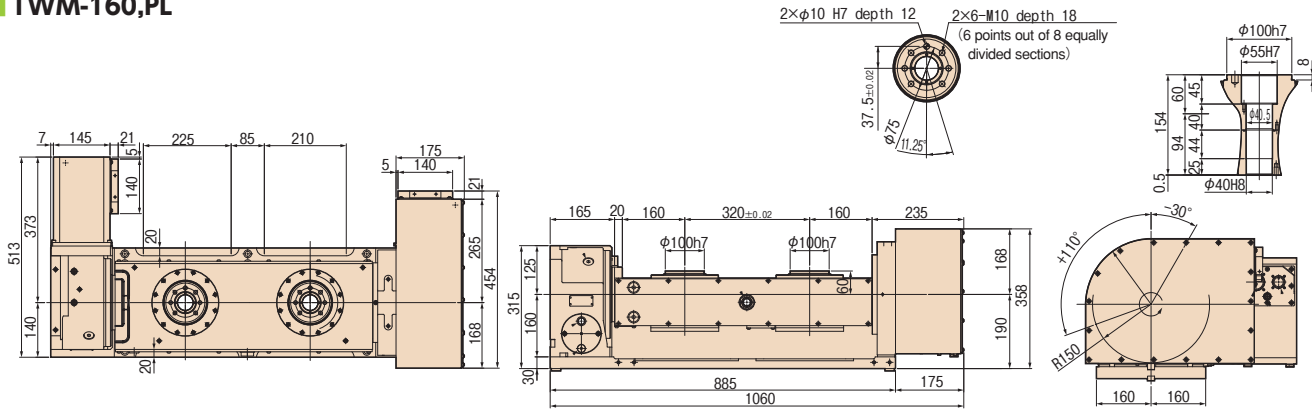

TWM-250,PS

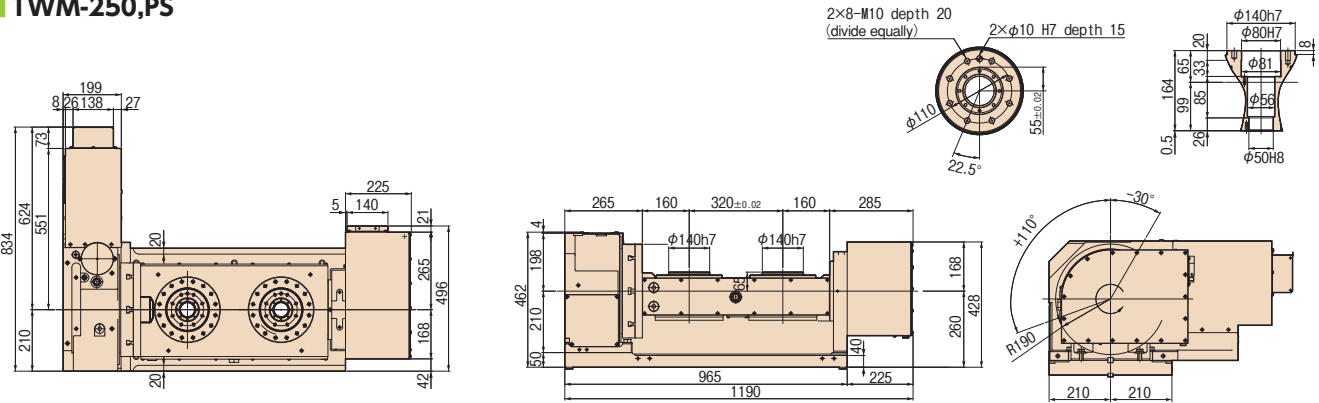

TWM-250,PL

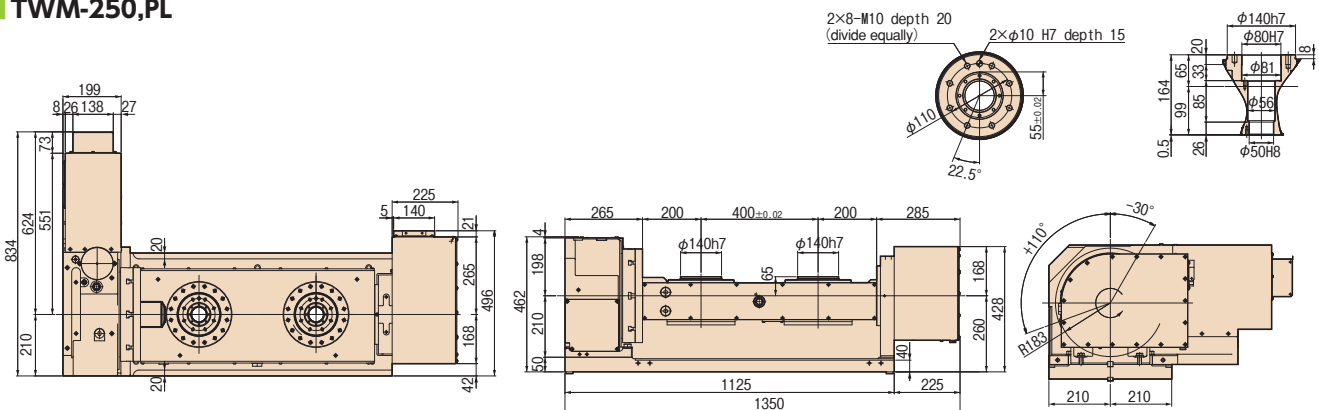

Note: The above dimensions are for FANUC servo motors. The dimensions of servo motors of other manufacturers may be larger.

RBS

TBS

RWE/RWA
RN

RWE/RWA-B
RNCV-B

RNCM

RWB

RWB-K
RNCK

RCH
RNC

RCV
RNCV

Multi-Spindle
RWM

TWA/TN

TTNC

THNC

Multi-Spindle
TWM

RDS

RTV
RTT

RCB

NC Controllers

Accessories

Options

Technical
Information

SmartDD

RDS RDS-200



RDS-200

Smart slim body provides full use of machining area with various features of DD motor including high speed rotation. This is the best model for mass-production of automobile and computer parts at small machining centers.

RBS

TBS

RWE/RWA
RN

RWE/RWA-B
RNCV-B

RNCM

RWB

RWB-K
RNCK

RCH
RNC

RCV
RNCV

Multi-Spindle
RWM

TWA/TN

TTNC

THNC

Multi-Spindle
TWM

RDS

RTV
RTT

RCB

NC Controllers

Accessories

Options

Technical
Information

Specifications

Unit: mm

		RDS-200	
Spindle diameter	mm	φ83	
Center height	mm	160	
Center bore	Nose diameter	φ55	
	Through-bore	φ45	
Motor type		TSUDA-02	
Net weight	kg	65	
Speed reduction ratio		1/1	
Indexing accuracy (the sum)	sec	20※	
Clamp system		Pneumatic	
Clamp torque /pneumatic pressure 0.49MPa	N·m	600	
Clamp torque /Pneumatic pressure interception	N·m	40	
Table max. rpm	Steady rotation	min ⁻¹	100
	Max rotation	min ⁻¹	300
Allowable work weight	kg	100	
Allowable load (when table is clamped)		N	6,860
		N·m	600
		N·m	350

※Pitch error corrected

Dimensions

Unit: mm

RDS-200

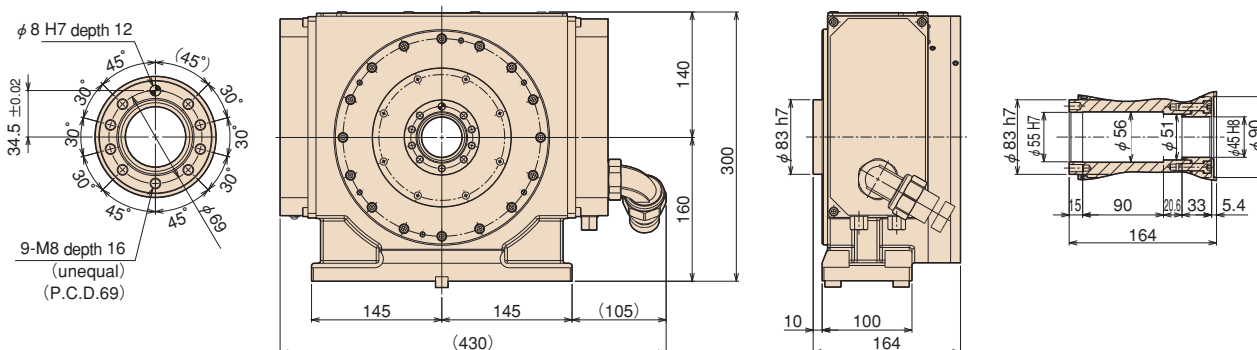

DD Table

RTV·RTT

RTV-202 RTT-112

DD (Direct Drive) motors realize high speed, high acceleration and no backlash operation. Most suitable for high speed and high quality machining for various impellers, blades and medical equipment, and for high speed indexing operation for automotive parts. We provide optimum ideas of products and various applications based on our great experiences.



RTV-202

Specifications

Unit: mm

	RTV-202		RTT-112	
	1-axis		2-axis	
Controll axis	Vertical setting only		Rotary axis	Tilt axis
Table diameter (Spindle diameter) mm	φ120		φ100	—
Servo motors (for FANUC)	Dis260/300		Dis60/400	Dis150/300
Type of scale	αCZI512S		αCZI512A	αCZI512A
Table max. rpm	min ⁻¹	150	150	100
Clamp torque	N·m	300 (Pneumatic pressure 0.49MPa)	—	80 (Pneumatic pressure 0.49MPa)
Center height	mm	190	280	
Rotary joint		—	—	
Allowable work weight	kg	50	30	
Net weight	kg	90	190	

- * Contact us for the following models.
 - Vertical type DD Table φ100~φ500
 - Tilting type DD Table φ100~φ630
- * Applicable for various kinds of DD motors which depend upon the type of controllers. Contact us for details.

Dimensions

Unit: mm

RTV-202

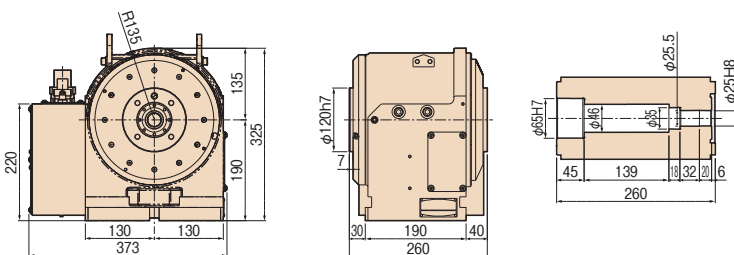

RTT-112

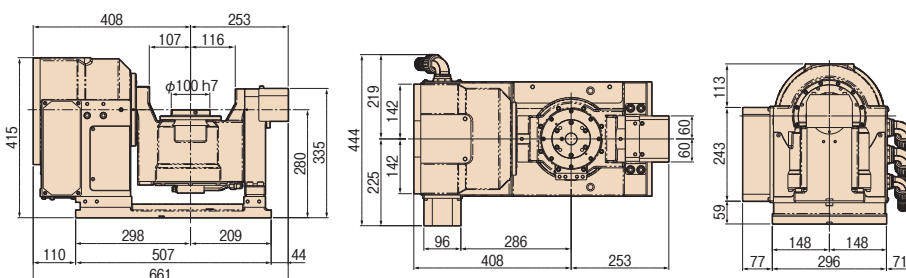

RTT-112

- RBS
- TBS
- RWE/RWA
RN
- RWE/RWA-B
RNCV-B
- RNCM
- RWB
- RWB-K
RNCK
- RCH
RNC
- RCV
RNCV
- Multi-Spindle
RWM
- TWA/TN
- TTNC
- THNC
- Multi-Spindle
TWM
- RDS
- RTV
RTT**
- RCB
- NC Controllers
- Accessories
- Options
- Technical Information

RCB RCB-350·450·550

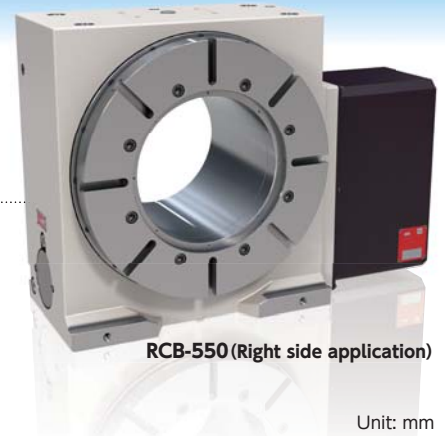





RCB-550 (Right side application)

Unit: mm

Main spindle with highly rigid bearings and table with high overall rigidity enable machining of hard materials such as aircraft components. Machining at a position closer to the face plate is made possible by inserting the workpiece through the large bore.

Specifications

		RCB-350	RCB-450	RCB-550
Handedness	R	○	○	○
	Top	○	○	○
Table diameter		φ 350	φ 450	φ 550
Center height		255	310	350
Center bore	Nose diameter	φ 245H7	φ 295H7	φ 345H7
	Through-bore	φ 216	φ 265	φ 315
Table T-slot width		14H7	14H7	18H7
Guide block width		18h7	18h7	18h7
Servo motors (for FANUC)		α iF12	α iF22	α iF22
Inertia converted into motor shaft	$\times 10^{-3} \text{kg} \cdot \text{m}^2$	3.48	6.14	5.84
	$[\times 10^{-3} \text{kgf} \cdot \text{cm} \cdot \text{sec}^2]$	[35.50]	[62.63]	[59.57]
Net weight	kg	330	520	720
Speed reduction ratio		1/90	1/90	1/120
Table max. rpm	min^{-1}	22.2	22.2	16.6
	(Motor rpm: 2,000 min^{-1})			
Indexing accuracy (the sum)	sec	15	15	15
Clamp system		Hydraulic	Hydraulic	Hydraulic
Clamp torque	N·m	3,300	4,700	6,500
	∕ hydraulic pressure 3.5MPa [35kgf/cm ²]	[337]	[479]	[663]
Strength of worm gears	N·m [kgf·m]	1,942 [198]	3,276 [334]	4,716 [481]
Allowable work weight	Vertical setting  kg	400 (800)	700 (1,400)	1,000 (2,000)
	() : with tailstock			
Allowable load (when table is clamped)	F  N [kgf]	50,000 [5,099]	85,000 [8,668]	150,000 [15,296]
	F × L  N·m [kgf·m]	3,300 [337]	4,700 [479]	6,500 [663]
Accessories	F × L  N·m [kgf·m]	3,600 [367]	7,300 [744]	15,000 [1,530]
	Options			
Allowable work inertia	$J = \frac{W \cdot D^2}{8}$  $\text{kg} \cdot \text{m}^2$ [kgf·cm·sec ²]	6.1 [62]	17.7 [180]	37.8 [385]

Dimensions

Unit: mm

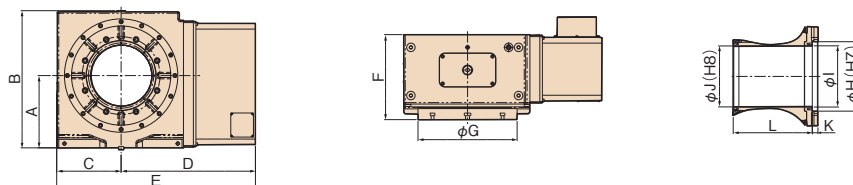

Unit: mm

	A	B	C	D	E	F	G	H	I	J	K	L
RCB-350R	255	484	227	474	701	300	φ 350	φ 245	φ 216	φ 215	20	279
RCB-450R	310	579	267	584	851	340	φ 450	φ 295	φ 265	φ 270	20	319
RCB-550R	350	659	307	624	931	365	φ 550	φ 345	φ 315	φ 320	20	344

Single axis NC controllers equipped with advanced functions for M-signal

Single axis NC table controllers that operate by means of M-signals from the machining center. Operation can be programmed by machining center under "Remote mode + M" specification.

For small-sized rotary tables

TPC-Jr K2/K3

Single axis NC controllers that operate small-sized TSUDAKOMA NC rotary tables by means of M-signals from machining center.

TSUDAKOMA rotary tables equipped with super-compact AC servo motors are the most compact among similar models.

Operation can be programmed by machining center.

With "Remote mode + M" specification

(Parameter change) P.47

※Corresponding to Cable option

Manual Pulse Generator (Option)



Applicable models

	K2	K3
RN-100	●	
RWE/RWA-160	●	
RWE/RWA-200		●
RWA-250		●
RWA-320		●
RN-100-2 (Axis) / 3 (Axis) / 4 (Axis)		●
RN-150R-2 (Axis)		●
TN-101	●	
TWA-130	●	
TWA-160	●	
TWA-200		●
TBS-130	●	
TBS-160	● (R)	● (T)

Dimensions

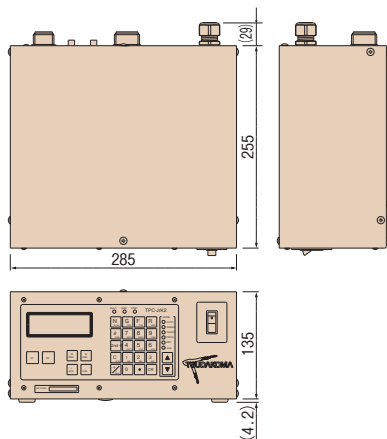

Cables

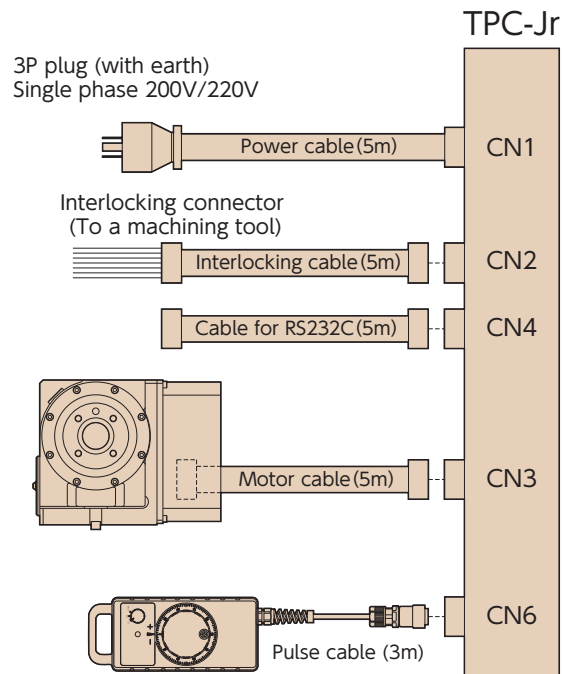

Note: The cable for RS232C is an optional item.
Note: Manual pulse generator is an optional item.

RBS

TBS

RWE/RWA
RN

RWE/RWA-B
RNCV-B

RNCM

RWB

RWB-K
RNCK

RCH
RNC

RCV
RNCV

Multi-Spindle
RWM

TWA/TN

TTNC

THNC

Multi-Spindle
TWM

RDS

RTV
RTT

RCB

NC Controllers

Accessories

Options

Technical Information

TPC-Jr FUNCTIONS

Operation panel



OPERATION MODE

- **AUTO** **AUTO :**
Automatic operation by an M signal from the machining center.
- **SINGLE** **SINGLE :**
Single operation of TPC-Jr. By pressing **ST**, positioning is performed once.
- **CHECK** **CHECK :**
Block number call, program check and self-diagnosis.
- **PROG** **Program mode :**
For inputting and editing the program.
- **MDI** **MDI mode :**
For setup operation. Ten blocks of programs can be carried out.
- **JOG** **JOG mode :**
For manual feed and step feed.
- **HANDLE** **Handle mode :**
Manual pulse operation.

Program edit keys

- 2nd-F** + **N** **Workpiece No. (Program No.)**
0000~ 9999
100 programs registerable
- N** **Block No.**
000~999
- G** **Operation command**
G0~G4: Movement command
G5 to G9: Assistance function
- F** **Feed rate select command**
F0: Rapid positioning speed
F1~ F9: Cutting feed rate
- R** **Assistance code for codes**
- θ** **Travel distance command (angle, divided number)**
Block No./Sub-program No.

G-code		R-code		θ-code	
No.	Command	No.	Command	Command	Setting
G0	Direct angle command	001~999	Number of Repetition (INC command)	Command angle	±000.001°~999.999°
		000	(ABS command)	Command angle	±000.000°~360.000°
G1	Direct indexing number command	001~999	Number of repetitions	Number of divisions for 360°	±1~999999div.
G2	Arc-indexing number command	001~999	Number of divisions, Number of repetitions	Arc-angle indexed	±000.001°~360.000°
G3	Lead cutting command	000~100	Number of table rotations	Command angle	±0°~360.000°
G4	Zero point return command	000	1st zero point return (mechanical zero point)		Not required
		001	2nd zero point return		
		002	3rd zero point return		
G5	Sub-program call command	001~999	Number of repetitions	Sub-program No.	0000~9999
G6	Subprogram return command		Not required		Not required
G7	Program end command		Not required	Target address	000~999
G8	Workpiece coordinate system setting command		Not required	Reference coordinate	±0°~360.000°
G9	Declaration command	000	No operation		Not required
		001/002	Clamp OFF/ON		
		003/004	Dowel OFF/ON	Dwell time	000~999 (×10m sec)
		005/006	Indexing group control OFF/ON		Not required
		007/008	Directional positioning OFF/ON		
		009/010	Completion signal control command OFF/ON	Completion signal selection	
		011	Program display selection command		Not required
		012	Current position display selection command		
		013	Remaining angle display selection command		

For large-sized tables

TPC5 SR6 / SR12 / SR30

Single axis NC controllers automatically start large-sized TSUDAKOMA NC rotary tables by receiving M-signals from machining center.

Easy programming by simple input of the interactive system.

In increments of 0.001° (standard), 0.0001° or 1 sec.

Ready to set optional functions easily.

- With an optional function of B signal, the workpiece number, block number and tilting angle command can be entered from machining center.
- Operation can be programmed by machining center.
With "remote mode + M" specification
(Parameter change) **P.47**
 ※Corresponding to Cable option



- RBS
- TBS
- RWE/RWA
RN
- RWE/RWA-B
RNCV-B
- RNCM
- RWB
- RWB-K
RNCK
- RCH
RNC
- RCV
RNCV
- Multi-Spindle
RWM
- TWA/TN
- TTNC
- THNC
- Multi-Spindle
TWM
- RDS
- RTV
RTT
- RCB

Applicable models

	SR6	SR12	SR30
RNCM-251	●		
RNCM-301~631		●	
RWB-250	●		
RWB-320,400,500		●	
RCH/RCV-800		●	
RCH/RCV-1000,1250			●
RNCV-1501,2001			●
TN-320	●		
TN-450			●
THNC-251	●		
THNC-301	●		
TTNC-631		●	
RBS-160	●		
RBS-250	●		
RBS-320		●	
TBS-250	●		

Cables

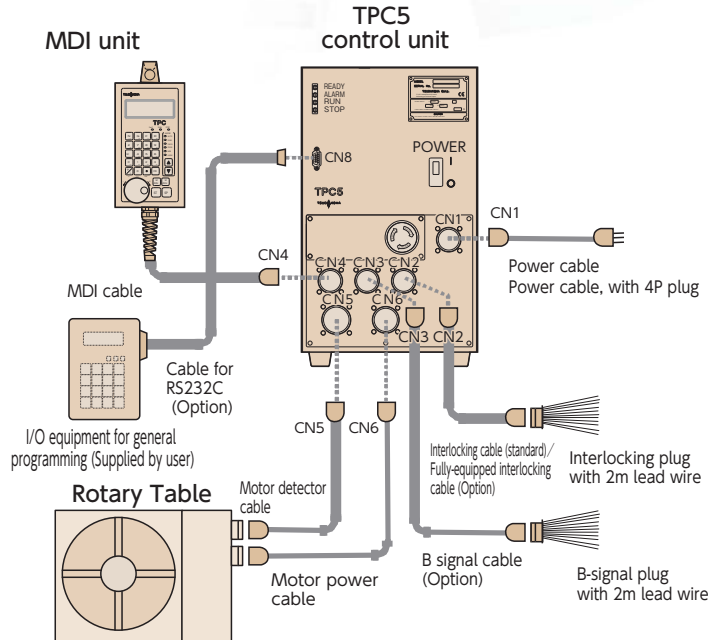

Dimensions

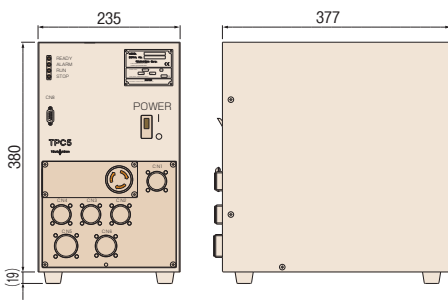

- NC Controllers
- Accessories
- Options
- Technical Information

TPC5 FUNCTIONS

Operation panel

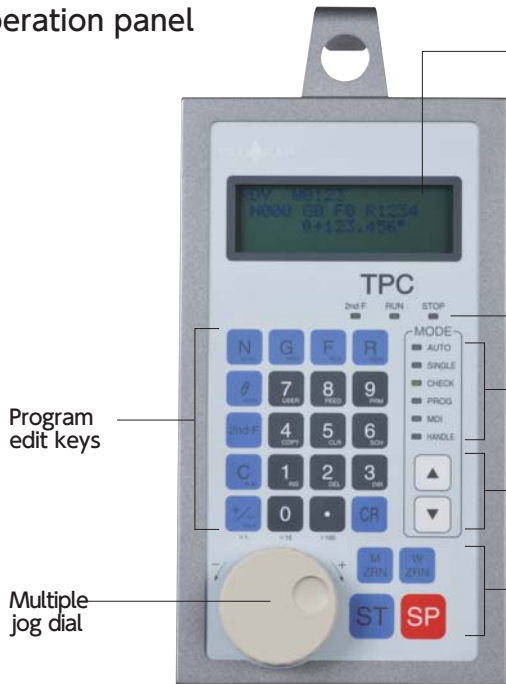

Indicator

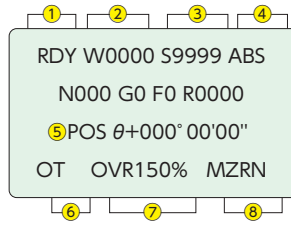

- ← Status display line
- ← Program display line
- ← Program/Current position
- ← Control display line

- Status display line:
 - ① TPC status
 - ② Workpiece number
 - ③ Subprogram number
 - ④ Command system
- Program display line:
 - TPC5 program in 2 lines
 - ⑤ Current position/remaining (POS/REM)
- Control display line:
 - ⑥ Overtravel
 - ⑦ Override/machine lock/manual interrupt
 - ⑧ Zero point return MZRN/WZRN/TZRN

Program edit keys

Multiple jog dial

LED displays

LED for operational mode

Operation mode change key

Operation keys

Program edit keys

2nd-F + **N** _{W No.} Workpiece No. (Program No.)
0000~9999
100 programs registerable

N _{W No.} Block No. 000~999

G _{PRO} Operation command
G0~G4 : Movement command
G5 to G9 : Assistance function

F _{POS} Feed rate select command
F0 : Rapid positioning speed
F1~F9 : Cutting feed rate

R _{REM} Assistance code for codes

θ _{DIGV} Travel distance command (angle, divided number)

OPERATION MODE

- AUTO** AUTO : Automatic operation interlocked with machining center
- SINGLE** SINGLE : Single operation of TPC5
- CHECK** CHECK : Program check and self-diagnosis
- PROG** Program mode : Program entry
- MDI** MDI mode : Setup operation
- HANDLE** Handle mode : Manual pulse operation/jog mode

G-code		R-code		θ-code	
No.	Command	No.	Command	Command	Setting
G0	Direct angle command	0001~9999	Number of Repetition (INC command) (ABS command)	Command angle	±000.001°~999.999°
		0000		Command angle	±000.000°~360.000°
G1	Direct indexing number command	0001~9999	Number of repetitions	Number of divisions for 360°	±1~999999div.
G2	Arc-indexing number command	0001~9999	Number of divisions, Number of repetitions	Arc-angle indexed	±000.001°~360.000°
G3	Lead cutting command	0000~0100	Number of table rotations	Command angle	±0°~360.000°
G4	Zero point return command	0000	1st zero point return (mechanical zero point)		
		0001	2nd zero point return		Not required
		0002	3rd zero point return		
G5	Sub-program call command	0000~9999	Number of repetitions	Sub-program No.	0000(0001)~9999
G6	Subprogram return command		Not required		Not required
G7	Program end command		Not required	Target address	000~999
G8	Workpiece coordinate system setting command		Not required	Reference coordinate	±0°~360.000°
G9	Declaration command	0000	No operation		Not required
		0001/0002	Clamp OFF/ON		
		0003/0004	Dowel OFF/ON	Dwell time	001~999 (×10m sec)
		0005/0006	Indexing group control OFF/ON		Not required
		0007/0008	Directional positioning OFF/ON		Not required
		0009/0010	Completion signal control command OFF/ON	Completion signal selection	
		0011	Program display selection command		
		0012	Current position display selection command		Not required
		0013	Remaining angle display selection command		

Specifications of TPC

	TPC-Jr	TPC5
Control axis	1 axis	
Servo motor	AC servo: ABS detector	
Command unit	0.001° (Decimal)	1 sec, 0.001°, 0.0001° (Decimal)
Indexing	1~999999 even indexing	
Direct indexing number	1~999999 even indexing	
Arc-indexing	1~999 even indexing	1~9999 even indexing
Max. command angle	±999.999°	±999°59'59", ±999.999°, ±999.9999°
Command system	INC, ABS, Shortcut ABS, INC/ABS mixed system	
Input system	MDI	
Program control	Workpiece No. (W0000 to 9999)	
Program capacity	1,000 blocks (Total of main and sub programs)	2,000 blocks (Total of main and sub programs)
Positioning speed	Max, motor rotation speed: 3,000rpm	Max, motor rotation speed: 2,000rpm
Operation Mode	AUTO: Operation interlocked with a machining center SINGLE: Single operation of TPC CHECK: Program check and call PROG: Program edit MDI: Setup operation JOG: Manual feed, step feed HANDLE: Manual pulse operation	AUTO: Operation interlocked with a machining center SINGLE: Single operation of TPC CHECK: Program check and call PROG: Program edit MDI: Setup operation HANDLE: Manual pulse operation
Display	OELD 20 figures× 4lines	Liquid crystal display 20 figures×4lines
Direct indexing number command	Move angle is directly commanded	
Repetition	Command of number of move amount repetitions 999 (TPC-Jr) 1~9999 (TPC5)	
Direct indexing number command	Indexing number of six digits for 360 degrees	
Arc-indexing number command	Command of arbitrary 3-digit angle (TPC-Jr) or 4-digit angle (TPC5)	
Lead cutting command	Interlocked operation with one axis of the machining center in the open loop status	
Zero point return command	Allows return to the first, second or third-zero point	
Feedrate command	F0: positioning speed F1~9: cutting feedrate	
Feedrate setting	1. By radius and surface speed setting 2. By move amount per second	
Sub-program	Up to eight levels of nesting are possible	
Workpiece coordinate system setting	Allows a workpiece coordinate to be set at any point	
Dwell	Allows output of a positioning completion signal to be delayed	
Single directional positioning	Allows positioning in one direction	
Backlash compensation	In increments of 0.001°	Setting by command unit
Soft limit function	Sets a soft limit measured from the 1 st zero position	
Automatic setting at power ON	1. Mode selection, AUTO/CHECK 2. Workpiece number setting 3. Block number setting	
Edit function	1. Insert 2. Delete 3. COPY	
Alarm	1. Program format errors 2. Program memory errors 3. Communication errors 4. Soft limit alarms 5. Overtravel 6. Servo motor alarms 7. Overheat in the cabinet (TPC5)	
Override function	×	5~200% 5% steps
JOG/HANDLE feeding	Manual pulse feed, Jog feed, step feed	Manual pulse feed, jog feed
Overtravel	The rotation range of the rotary table can be limited by limit switches. (Standard tilting axis)	
Manual 2 nd zero setting	Enables the 2 nd zero position to be set and changed at any point in the JOG (HANDLE) mode	
Input/output signal check	○	
Contrast	The concentration on the LCD screen can be adjusted	
Power	1φ200/220V±10% 50/60Hz	3φ200/220V±10% 50/60Hz
Earth (less than 100 ohm earth resistance)	Model Power capacity Fuse rating Jr K2 1.2KVA 10A Jr K3 1.9KVA 15A	Model Power capacity Fuse rating TPC5-SR6 2.3KVA 10A TPC5-SR12 4.0KVA 15A TPC5-SR30 5.9KVA 20A
Environmental conditions	Ambient temperature: 0-40 degree Relative humidity: 20-80% (no condensation) Vibration: 0.3G or less, No corrosive gas	
Weight	Jr K2 unit Weight: 7.0kg 285mm (W)×255mm (D)×135mm (H) Jr K3 unit Weight: 7.6kg 285mm (W)×255mm (D)×135mm (H)	Control unit Weight: 15kg 235mm (W)×377mm (D)×380mm (H) MDI unit Weight: 0.5kg 111mm (W)×30mm (D)×199mm (H)
External output signal	From TPC to machining center Contact ratings: DC24V, 0.1A or less	

	TPC-Jr	TPC5
FIN1	Positioning completion signal during interlocking operation	
	●	●
FIN2	Output of G7 completion or workpiece number setting completion (selectable by parameters)	
	● (AUTO mode)	◇
FIN3	Output of G7 completion or workpiece number setting completion (selectable by parameters)	
	×	◇
FIN4	Output of zero position (selectable by parameters)	
	×	◇
Workpiece number setting completion	●	◇
In AUTO mode	Output in AUTO mode	
	×	◇
LEVEL	Output during positioning (selectable by parameters)	
	● (Rotary table zero position)	◇
ALARM	Output in when alarm detected	
	●	◇
External input signal	From machining center to TPC (External power DC24V is also available.)	
START	Positioning start signal during interlocking operation (M-signal)	
	●	●
STOP	Input to stop rotary table	
	●	●
INTERLOCK	Input to interlock rotary table	
	×	◇
Selection of outer program	Workpiece number can be set externally	
	●	◇
BF (Strobe signal)	Strobe signal for setting workpiece number externally	
	●	◇
M-signal	M signal data fixed input system	
	● (6 points)	◇ (16 points)
MDI lock	Input for locking MDI key operation	
	×	◇
Zero point return	1st zero return command	
	●	◇
Manual pulse generator	Manual operation can be performed with a manual pulse generator	
	● (Movement magnification: ×1, ×10, ×100)	
Full-closed feedback control	×	Enable full-closed control (highly precise) with the Inductosyn or rotary encoder
MP scale	Detecting unit 0.0001° (360poles) or 0.00005° (720poles)	
	×	◆
Encoder	Detecting unit 0.0001° or 0.00005°	
	×	◆
Serial channel	TPC program, feed rate and parameters can be stored in an external device	
	Format: ISO	Format: ISO
	◆ (RS232C)	◆ (RS232C)
Cable supplied (standard)	Between rotary table and TPC-Jr (1 pc) For Motor: 5m	Between rotary table and TPC5 (2 pcs.) For motor power supply: 5m For motor detector: 5m
	—	Between TPC5 and MDI unit: 7m
	Power cable: 5m	Power cable: 5m
	Interlocking cable: 5m	Interlocking cable: 5m
Cable supplied (Option)	Cables of different length are available	
	RS232C cable: 5m	Interlocking cable: 5m
	Manual pulse generator (cable) 3m	B signal cable: 5m
	—	RS232C cable: 5m

- : Standard
- ◇: Optional interlocking cables are supplied
- ◆: Optional units and parts are supplied

RBS

TBS

RWE/RWA
RNRWE/RWA-B
RNCV-B

RNCM

RWB

RWB-K
RNCKRCH
RNCRCV
RNCVMulti-Spindle
RWM

TWA/TN

TTNC

THNC

Multi-Spindle
TWM

RDS

RTV
RTT

RCB

NC Controllers

Accessories

Options

Technical
Information

TPC Option

RBS

TBS

RWE/RWA
RN

RWE/RWA-B
RNCV-B

RNCM

RWB

RWB-K
RNCK

RCH
RNC

RCV
RNCV

Multi-Spindle
RWM

TWA/TN

TTNC

THNC

Multi-Spindle
TWM

RDS

RTV
RTT

RCB

NC Controllers

Accessories

Options

Technical
Information

TPC5 Full-featured interlocking cable

☞ P.50

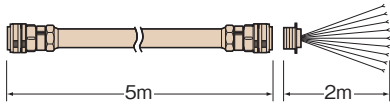

Required for the following functions:

- Stop or interlock input signal
- Positioning completion 2,3,4
- AUTO mode
- Positioning
- Alarm signal

- Full-featured interlocking cable (Standard length: 5m)

TPC5 B signal cable

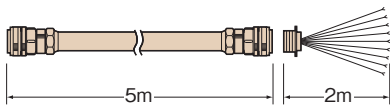

Required for the following functions:

- External input of workpiece numbers
- External input of angles
- Fixed data input through M-signal

※ For using B signal cable, internal harness shall be added.

- B signal cable (Standard length: 5m)

TPC-Jr TPC5 RS232C cable

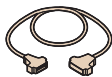

Input and output of program, parameter and feed data for TPC5 and TPC-Jr, and data printout are carried out through external equipment, which is to be prepared by the customer. Also, the cables can be arranged by the customer.

- RS232C cable (Standard length: 5m)

TPC5 High resolution capability Rotary Encoder type

☞ P.61



Fully-closed loop control is possible by the feed-back from the rotary encoder.

- Rotary encoders
- IBV unit (by HEIDENHAIN)
- TPC5 RE

TPC5 High resolution capability MP Scale type

☞ P.61



Fully-closed loop control is possible by the feed-back from the MP scale.

- MP scale
- A/D converter (Mitsubishi Heavy Industries)
- TPC5 RE

TPC-Jr TPC5 "Remote Mode" specification

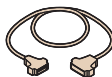

Available for measuring system construction. To be connected with a personal computer using serial channel.

- RS232C cable

TPC-Jr TPC5 "Remote Mode + M" specification

☞ P.47



To unify the program to start the rotary table by M-signal, by feeding a command for the indexing angle from the RS232C port at the NC controller of the machining center.

Note: This function may not be available for some machining centers. For details, ask the M/C manufacturer.

- RS232C cable

TPC-Jr Manual pulse generator

Handle feed is available by turning the dial of a manual pulse generator. A dial rotation can feed 100 pulse and the magnification of step feeding angle can be selected among x1, x10 and x100.

- Manual pulse generator (Cable length 3m)

TPC Machining Program Examples by TPC Controller

RBS

TBS

RWE/RWA
RN

RWE/RWA-B
RNCV-B

RNCM

RWB

RWB-K
RNCK

RCH
RNC

RCV
RNCV

Multi-Spindle
RWM

TWA/TN

TTNC

THNC

Multi-Spindle
TWM

RDS

RTV
RTT

RCB

NC Controllers

Accessories

Options

Technical
Information

Direct angle command : G0

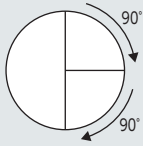

```

N000 G0 F0 R002 θ90.000 CR
      Quick Number of Repetition Indexing angle/time
N001 G7 θ000 CR
      End of program
  
```

Positioning at 90° twice

Return to N000 at the program end

Direct indexing number command(even indexing) : G1

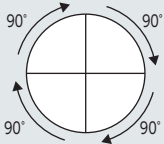

```

N000 G1 F0 R004 θ000004d CR
      360° is divided into quarters
N001 G7 θ000 CR
  
```

Dividing 360° by 4, four times

Return to N000 at the program end

Arc-indexing number command(even indexing by an arbitrarily-set angle) : G2

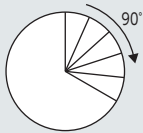

```

N000 G2 F0 R005 θ120.000 CR
      Indexing number Angle for indexing
N001 G7 θ000 CR
  
```

Dividing 120° by 5, five times

Return to N000 at the program end

Uneven indexing

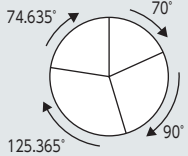

```

N000 G0 F0 R001 θ70.000 CR
N001 G0 F0 R001 θ90.000 CR
N002 G0 F0 R001 θ125.365 CR
N003 G0 F0 R001 θ74.635 CR
N004 G7 θ000 CR
  
```

Positioning at 70° once

Positioning at 90° once

Positioning at 125.365° once

Positioning at 74.635° once

Return to N000 at the program end

(-) direction indexing

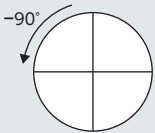

```

N000 G0 F0 R001 θ-90.000 CR
      Reverse
N001 G7 θ000 CR
  
```

Positioning at -90° once

Return to N000 at the program end

Zero point return command : G4

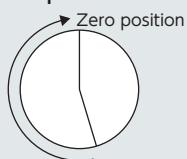

```

N000 G4 R000
      Zero return To 1st zero position
  
```

Return to 1st zero position

Remote mode + M specification(Parameter change) ※Corresponding to cable option

The rotary table is controlled by TPC with M-signal sent from a machining center through RS232C.

Note: This function may not be available for some machining centers. For details, ask the M/C manufacturer.

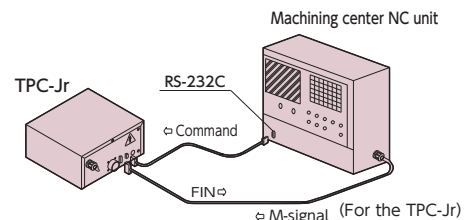

Machining center :

Program using Custom Macro Necessary equipment TPC-Jr : Software for remote mode RS232C/interlock cable, RS232C cross cable
NC unit for a machining tool : RS232C connector and Custom Macro B (optional) (for FANUC).
For details, ask the machine manufacturer.

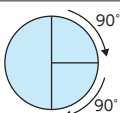

```

POPEN ;
DPRNT[/MOVA90.] ;
M70 ;
GO1Z100.F200 ;
  
```

```

DPRNT[/MOVA180.] ;
M70 ;
GO1Z100.F200 ;
PCLOS ;
  
```

RS232C port opens
Command of absolute positioning at 90 is transmitted to TPC
Positioning starts
Machining center in operation
Command of absolute positioning at 180 is transmitted to TPC
Positioning starts
Machining center in operation
RS232C port closes

Installation of TPC controller

- RBS
- TBS
- RWE/RWA
RN
- RWE/RWA-B
RNCV-B
- RNCM
- RWB
- RWB-K
RNCK
- RCH
RNC
- RCV
RNCV
- Multi-Spindle
RWM
- TWA/TN
- TTNC
- THNC
- Multi-Spindle
TWM

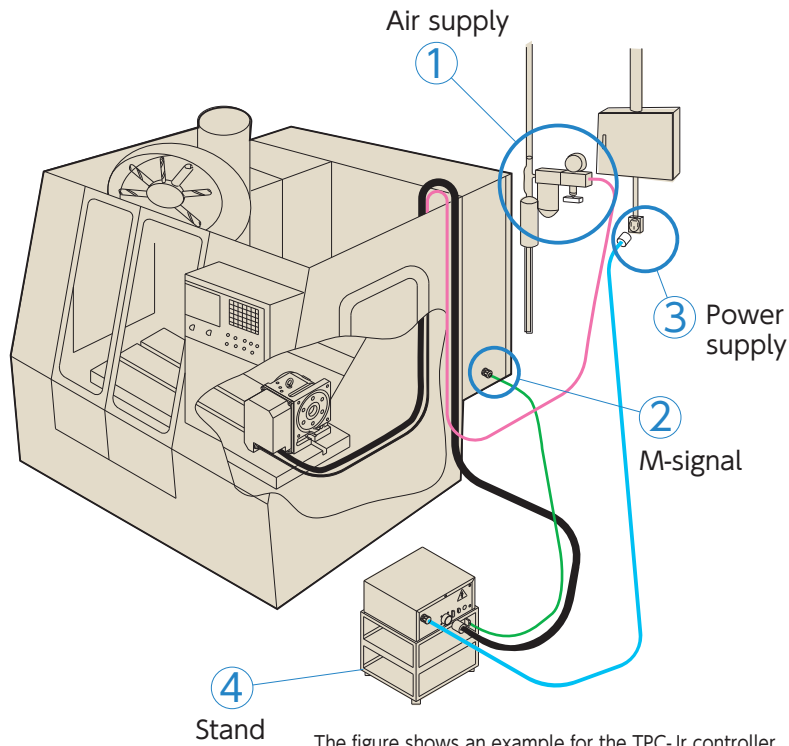

The figure shows an example for the TPC-Jr controller.

To be provided by customers

① Air supply

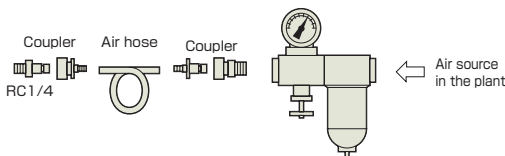

Air supply is necessary the pneumatic or air-hydraulic clamp system of the NC rotary tables with the TPC5 or TPC-Jr controller.

- The following are to be provided by customers:
- Air filter and regulator (Air pressure:0.49 MPa)
 - Air hose or air tube
 - Joint coupler (RC 1/4 for the table)

Some models need a 6mm diameter tube for connection.

② M-signal

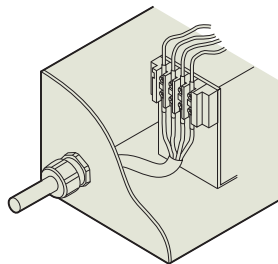

When the machining center controls the rotary table, it uses M-signals. Be sure to confirm with the machine manufacturer that M-signals or M-signal completion signals are transferred to the terminal block of the machine controller. If not, ask the manufacturer to do the required work.

☞ For the connection with an interlocking cable, refer to the examples shown on **P.49**

③ Power supply

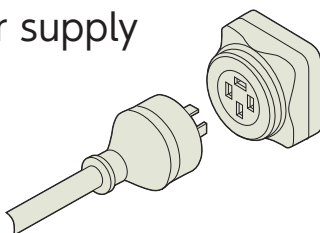

A socket for the TPC controller is necessary. A 3P plug is equipped with the TPC controller, and is recommended. The outlet for the connection is required.

TPC side connector WF4420(Panasonic)

Outer power supply connector WF1420 or the others(Panasonic)

In case of the different type of connector, shall be arranged by the customer.

☞ For the power capacity of each controller, refer to **P.45**

Conduct grounding (less than 100 ohm earth resistance)

④ Stand

A stand for the TPC controller is to be provided by the customer.

☞ For the dimensions and weight of the controller, refer to **P.41~43** **P.45**

TPC Controllers to Interlock with Machining Tools

TPC-Jr

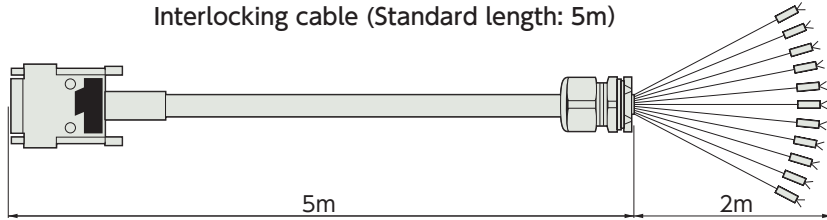

Connector dimension (on machining center)

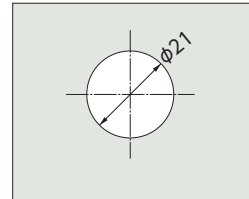

a) When a start signal and an indexing completion signal are used:

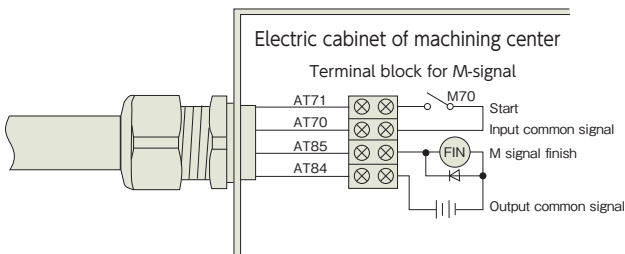

b) When all the signals through interlocking cables are used:

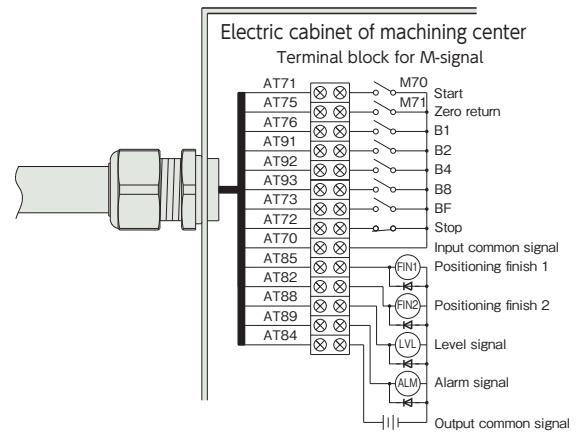

Note 1: When completion signals are received by a relay, the power supply should be 24VDC. Do not apply 100VAC or 200VAC.

Note 2: By changing the switch in the controller, a start signal is also available with the external power supply of 24VDC.

Note 3: Be sure to take countermeasures against electric noise by attaching surge protectors to relays for a machining center.

TPC5

Interlocking cable (Standard length: 5m)

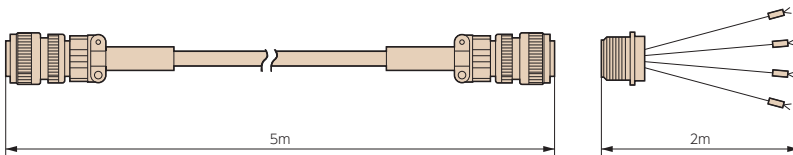

Connector dimension (To machining center)

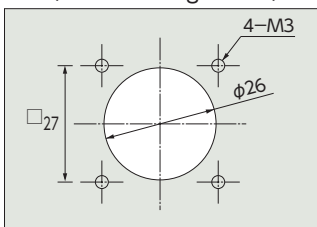

a) Standard interlock cable For interlocking only with M-signal and the completion signal

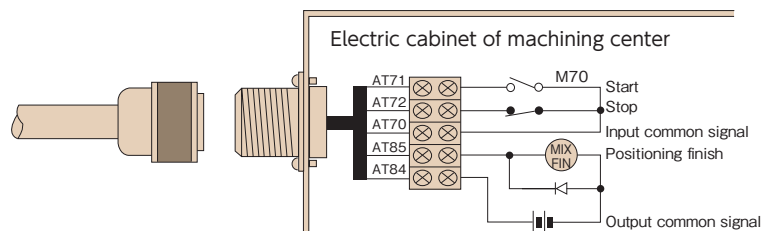

- RBS
- TBS
- RWE/RWA
RN
- RWE/RWA-B
RNCV-B
- RNCM
- RWB
- RWB-K
RNCK
- RCH
RNC
- RCV
RNCV
- Multi-Spindle
RWM
- TWA/TN
- TTNC
- THNC
- Multi-Spindle
TWM
- RDS
- RTV
RTT
- RCB
- NC Controllers

- Accessories
- Options
- Technical Information

TPC Controllers to Interlock with Machining Tools

b) Fully-equipped interlocking cable (Option)

A variety of signals such as a stop or interlock input signal and a level or alarm output signal are available with this cable.

B signal cable is required when the setting functions for the workpiece number and angle data are used, or when the fixed indexing angle input system by an M-signal is used.

If you want to see some examples of the connections with this cable, please contact Tsudakoma.

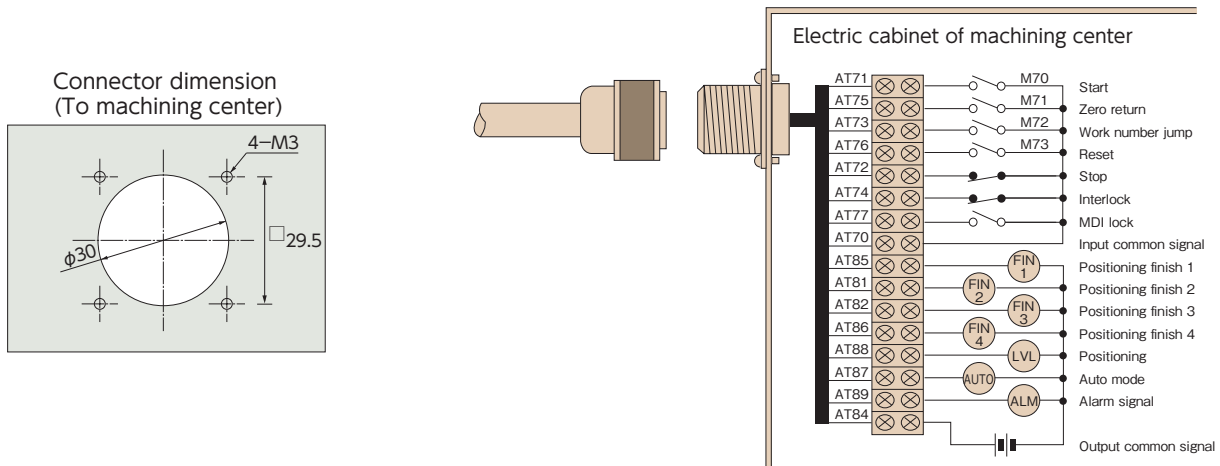

Note 1: When completion signals are received by a relay, the power supply should be 24VDC. Do not apply 100VAC or 200VAC.

Note 2: By changing the switch in the controller, a start signal is also available with the external power supply of 24VDC.

Note 3: Be sure to take countermeasures against electric noise by attaching surge protectors to relays for a machining center.

Time Chart

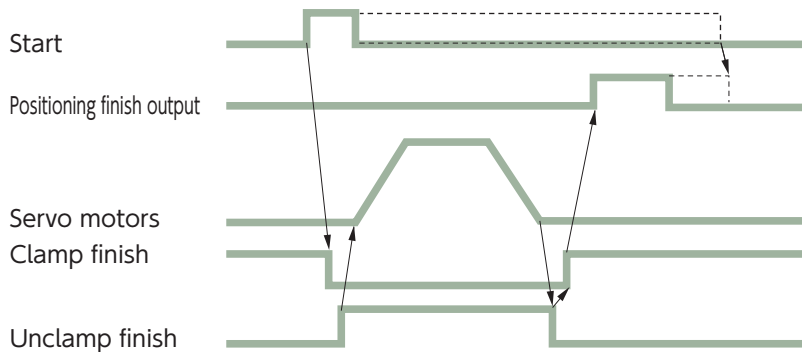

Note 1: A start input signal, in the form of either a pulse signal (of more than 10 msec) or level signal, can be accepted.

Note 2: During the interlocking operation with a machining center carried out through an M-signal, the M-signal should be completed by the positioning completion signal.

TPC Standard Cable Specifications

The tables below shows the maximum outer diameter and the curved radius of standard cables which are supplied with the rotary tables ready for the TPC5 or TPC-Jr controller.

Unit: mm

	Cable	Order Code	Max. outer dia	Min. curved radius
TPC5	Motor power cable	NS#20 (SANKEI MANUFACTURING CO.,LTD.)	20	90
	Motor signal cable			
TPC-Jr	Motor cable	NS#25 (SANKEI MANUFACTURING CO.,LTD.)	25	100

Model number, maximum outer diameter and curved radius may differ depending on specifications.

NC Rotary Tables / TPC-Jr Dimensions and Specifications

NC Rotary Tables / TPC-Jr

Unit: mm

RN-100R / TPC-JrK2

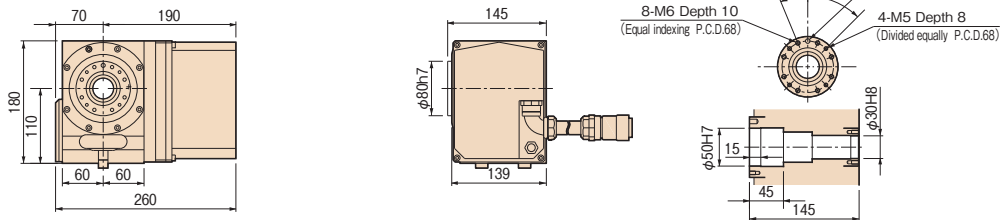

RWE/RWA-160R / TPC-JrK2

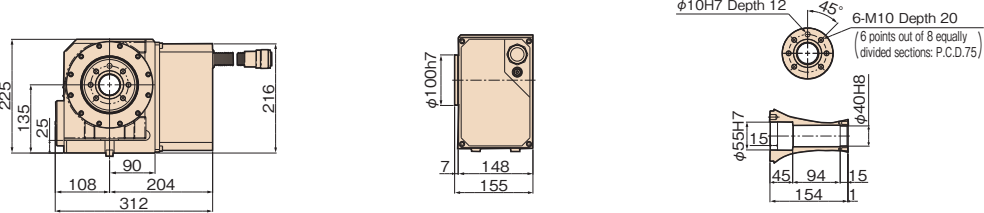

RWE/RWA-200R / TPC-JrK3

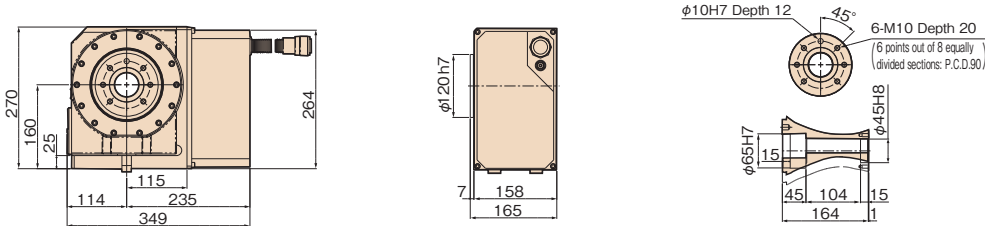

RWA-250R / TPC-JrK3

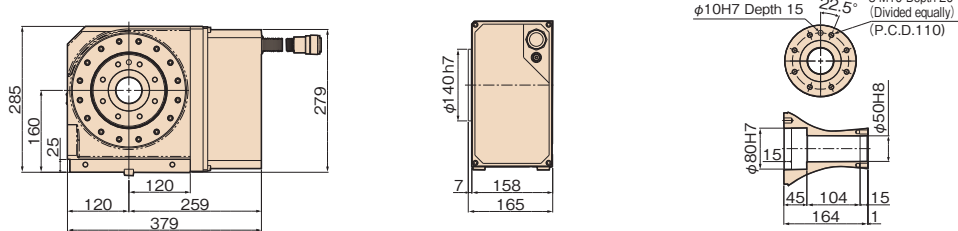

RWA-320R / TPC-JrK3

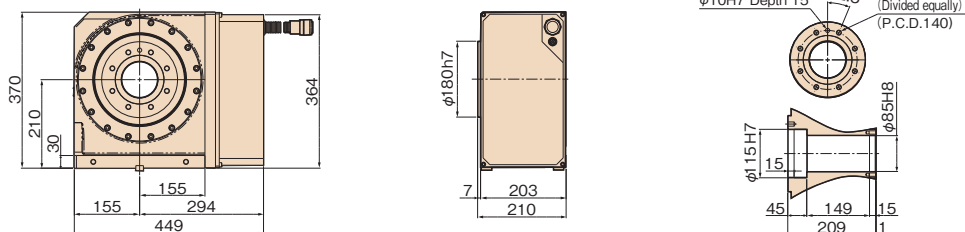

NC Table Specifications (with TPC-Jr)

	RN-100	RWE/RWA-160	RWE/RWA-200	RWA-250	RWA-320	RN-100-2	RN-100-3	RN-100-4
TPC-Jr	K2	K2	K3	K3	K3	K3	K3	K3
Reduction ratio	1/36	1/72	1/72	1/120	1/180	1/36	1/60	1/60
Max. rpm min ⁻¹	66.6/ Motor 2,400	41.6/ Motor 3,000	41.6/ Motor 3,000	25/ Motor 3,000	16.6/ Motor 3,000	55.5/ Motor 2,000	50/ Motor 3,000	50/ Motor 3,000

Note 1: Other specifications **P.14** **P.28**

Note 2: Contact us before an eccentric load is applied to the table due to continuous cutting feed or jigs.

RBS

TBS

RWE/RWA
RN

RWE/RWA-B
RNCV-B

RNCM

RWB

RWB-K
RNCK

RCH
RNC

RCV
RNCV

Multi-Spindle
RWM

TWA/TN

TTNC

THNC

Multi-Spindle
TWM

RDS

RTV
RTT

RCB

NC Controllers

Accessories

Options

Technical
Information

NC Rotary Tables / TPC-Jr Dimensions and Specifications

NC Tilting Rotary Tables / TPC-Jr

Unit: mm

- RBS
- TBS
- RWE/RWA
RN
- RWE/RWA-B
RNCV-B
- RNCM
- RWB
- RWB-K
RNCK
- RCH
RNC
- RCV
RNCV
- Multi-Spindle
RWM
- TWA/TN
- TTNC
- THNC
- Multi-Spindle
TWM
- RDS
- RTV
RTT
- RCB
- NC Controllers
- Accessories
- Options
- Technical Information

TWA-100 / TPC-JrK2

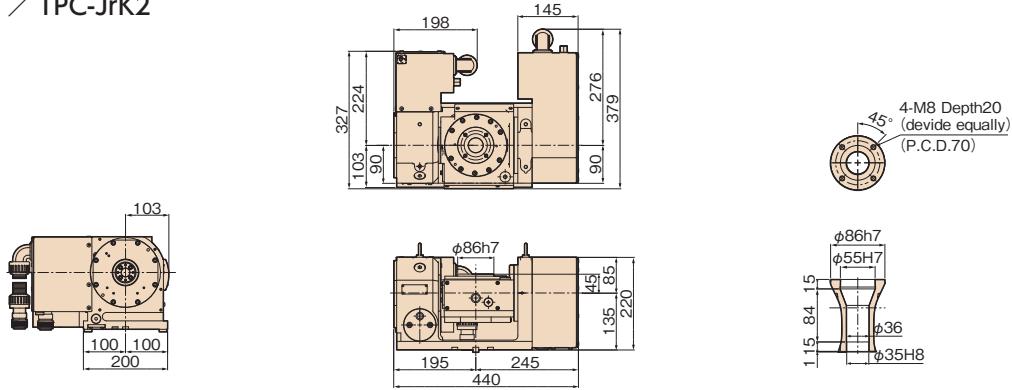

TWA-130 / TPC-JrK2

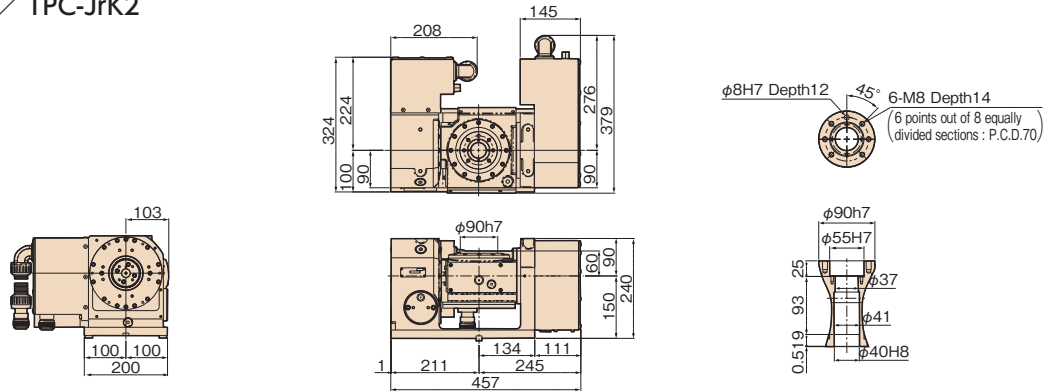

TWA-160 / TPC-JrK2

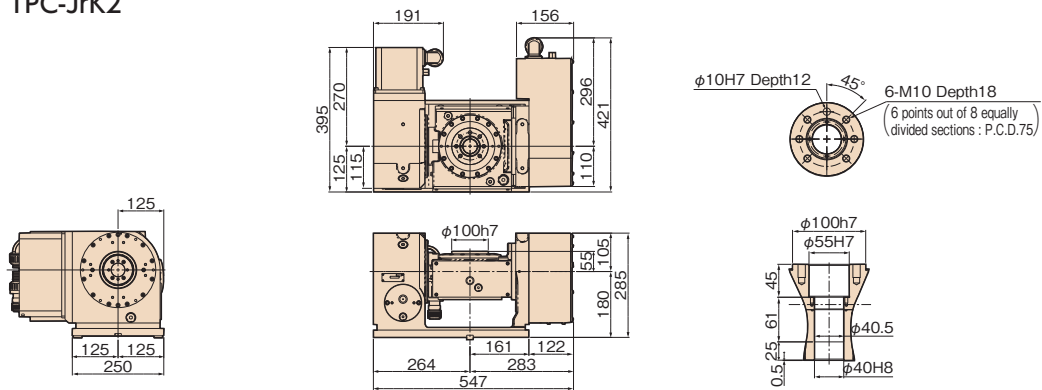

NC Tilting Tables Specifications (with TPC-Jr)

Control axis	TWA-100		TWA-130		TWA-160		TWA-200	
	Revolution	Tilt	Revolution	Tilt	Revolution	Tilt	Revolution	Tilt
TPC-Jr	K2		K2		K2		K3	
Reduction ratio	1/60	1/120	1/60	1/120	1/72	1/120	1/45	1/90
Max. rpm min ⁻¹	41.6/Motor 2,500	16.6/Motor 2,000	41.6/Motor 2,500	16.6/Motor 2,000	41.6/Motor 3,000	16.6/Motor 2,000	44.4/Motor 2,000	22.2/Motor 2,000

Note 1: Other specifications **P.30**

Note 2: Contact us before an eccentric load is applied to the table due to continuous cutting feed or jigs.

NC Tilting Rotary Tables / TPC-Jr

Unit: mm

TWA-200 / TPC-JrK3

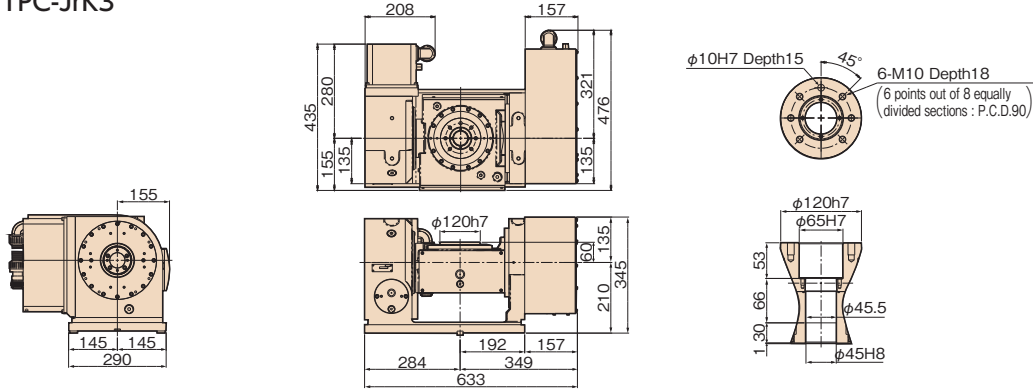

BallDrive NC Tilting Rotary Tables / TPC-Jr

Unit: mm

TBS-130 / TPC-JrK2

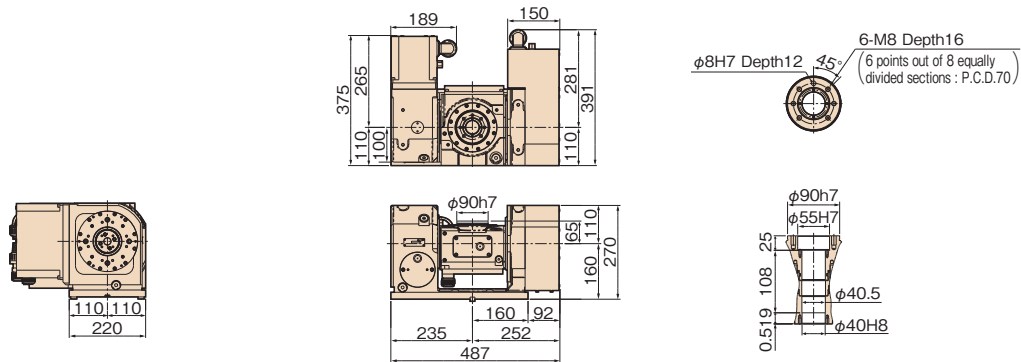

TBS-160 / Rotary axis: TPC-JrK2 Tilt axis: TPC-JrK3

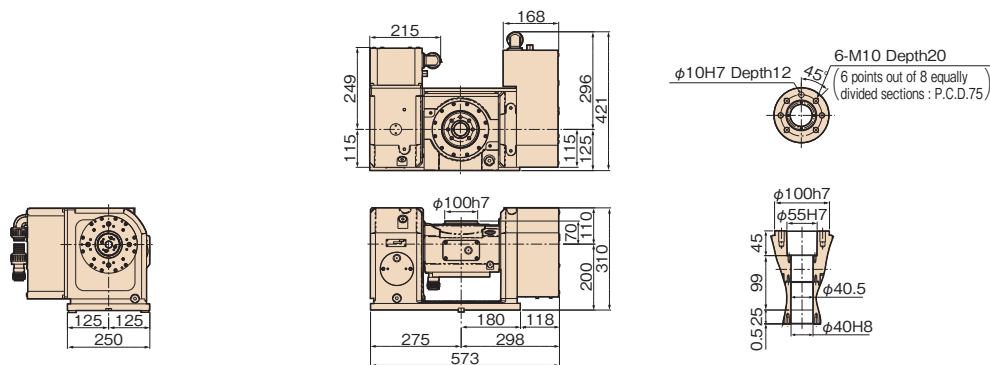

NC Tilting Tables Specifications (with TPC-Jr)

Control axis	TBS-130		TBS-160	
	Revolution	Tilt	Revolution	Tilt
TPC-Jr	K2		K2	K3
Reduction ratio	1/48	1/60	1/60	1/60
Max. rpm min ⁻¹	62.5/Motor 3,000	50/Motor 3,000	50/Motor 3,000	50/Motor 3,000

Note 1: Other specifications **P.12**

Note 2: Contact us before an eccentric load is applied to the table due to continuous cutting feed or jigs.

RBS

TBS

RWE/RWA
RN

RWE/RWA-B
RNCV-B

RNCM

RWB

RWB-K
RNCK

RCH
RNC

RCV
RNCV

Multi-Spindle
RWM

TWA/TN

TTNC

THNC

Multi-Spindle
TWM

RDS

RTV
RTT

RCB

NC Controllers

Accessories

Options

Technical
Information

Chuck

Scroll Chuck

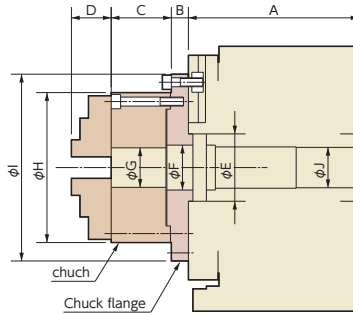

Chuck size (inch)	Chuck type	Outer chucking range (mm)	Inner chucking range (mm)
4	TC110F	2 ~ 106	36 ~ 102
5	TC130F	3 ~ 130	42 ~ 123
6	TC165F	3 ~ 156	52 ~ 148
7	TC190F	3 ~ 184	56 ~ 174
9	TC230F	4 ~ 214	64 ~ 202
10	TC273F	10 ~ 246	72 ~ 230
12	TC310F	10 ~ 275	82 ~ 265
15	TC385F	15 ~ 345	100 ~ 327
18	TC460F	15 ~ 410	152 ~ 436

Note 1: The values in the table above are the dimensions with hardened jaws. (Soft jaws are optional.)
 Note 2: Some workpieces, even in the chucking range, may not be chucked due to jaw configuration.

Unit: mm

	Chuck size (inch)	A	B	C	D	E	F	G	H	I	J
RBS-160	4	170	18	58	31.3	55	45	24	112	112	40
	5			60	37.3			32	132	132	
	6			66	44.3			44	167	167	
	7			75	46.3			54	192	192	
RBS-250	5	180	18	60	37.3	80	65	32	132	132	50
	6		18	66	44.3			44	167	167	
	7		18	75	46.3			54	192	192	
	9		25	82	55.3			70	233	233	
RBS-320	6	225	18	66	44.3	115	100	44	167	167	85
	7		18	75	46.3			54	192	192	
	9		25	82	55.3			70	233	233	
	10		25	86	53.3			100	274	274	
RN-100	4	145	10	58	31.3	50	50	24	112	112	30
	5			60	37.3			32	132	132	
	4			58	31.3			24	112	112	
RWE/RWA-160	5	155	18	60	37.3	55	45	32	132	132	40
	6			66	44.3			44	167	167	
	7			75	46.3			54	192	192	
	5			18	60			37.3	32	132	
RWE/RWA-200	6	165	18	66	44.3	65	55	44	167	167	45
	7		18	75	46.3			54	192	192	
	9		25	82	55.3			70	233	233	
	5		18	60	37.3			32	132	132	
RWA-250	6	165	18	66	44.3	80	65	44	167	167	50
	7		18	75	46.3			54	192	192	
	9		25	82	55.3			70	233	233	
	6		18	66	44.3			44	167	167	
RWA-320	7	210	18	75	46.3	115	100	54	192	192	85
	9		25	82	55.3			70	233	233	
	10		25	86	53.3			100	274	274	
	12		25	92	59.3			110	310	310	
	5		20	60	37.3			32	132	168	
RNCM-251	6	165	20	66	44.3	40	30	44	167	167	32
	7		20	75	46.3			54	192	198	
	9		25	82	55.3			70	233	233	
	6		20	66	44.3			44	167	208	
RNCM-301	7	220	20	75	46.3	40	30	54	192	238	40
	9		25	82	55.3			70	233	233	
	10		25	86	53.3			100	274	274	
	12		25	92	59.3			110	310	318	
RNCM-401	7	250	20	75	46.3	40	30	54	192	238	40
	9		25	82	55.3			70	233	233	
	10		25	86	53.3			100	274	274	
	12		25	92	59.3			110	310	318	
RNCM-501	9	300	25	82	55.3	50	40	70	233	288	50
	12			92	59.3			110	310	378	

Unit: mm

	Chuck size(inch)	A	B	C	D	E	F	G	H	I	J	
RWB-250	6	180	18	66	44.3	105	65	44	167	208	80	
	7		18	75	46.3		65	54	192	236		
	9		25	82	55.3		76	70	233	233		
RWB-320	6	240	18	66	44.3	150	101	44	167	216	120	
	7		18	75	46.3			54	192	246		
	9		25	82	55.3			70	233	286		
	10		25	86	53.3			100	274	318		
RWB-400	12	275	25	92	59.3	200	151	110	310	318	160	
	7		20	75	46.3			54	192	286		
	9		25	82	55.3			70	233	286		
	10		25	86	53.3			100	274	336		
	12		25	92	59.3			110	310	370		
RWB-500	15	325	30	100	70.3	220	210	150	385	385	182	
	9		25	82	55.3			170	70	233		356
	12		25	92	59.3			210	110	310		386
	15		30	100	70.3			210	150	385		460
	18		35	114	79.8			210	180	460		500

Note 1: The above dimensions refer to power chucks by KOBAYASHI IRON WORKS CO., LTD.

Note 2: The flange type and the method of attaching the flange fixing bolt differ depending on the rotary table and the chuck size.

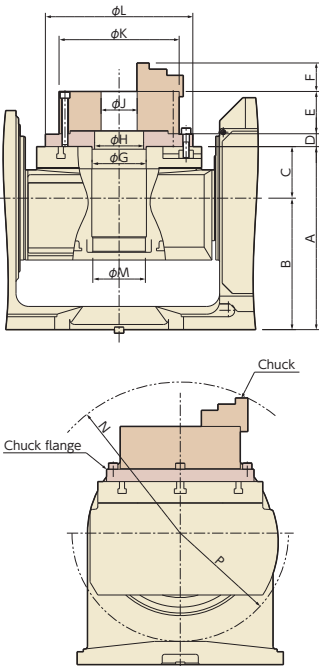

Unit: mm

Order Code	Chuck size (inch)	A	B	C	D	E	F	G	H	J	K	L	M	N	P
TBS-130	5	225	160	65	18	60	37.3	55	45	32	132	132	40	R198	R127
TBS-160	4	270	200	70	18	58	31.3	55	45	24	112	112	40	R191	R145
	5					60	37.3			32	132	132		R204	
	6					66	44.3			44	167	167		R223	
	7					75	46.3			54	192	192		R241	
TWA-100	4	180	135	45	15	58	31.3	55	45	24	112	112	35	R164	R106
	5	60	37.3	32	132	132	R177								
TWA-130	5	210	150	60	18	60	37.3	55	45	32	132	132	35	R193	R114
TWA-160	4	235	180	55	18	58	31.3	55	45	24	112	112	40	R176	R135
	5					60	37.3			32	132	132		R189	
	6					66	44.3			44	167	167		R208	
	7					75	46.3			54	192	192		R226	
TWA-200	5	270	210	60	18	60	37.3	65	55	32	132	132	45	R200	R148
	6					66	44.3			44	167	167		R219	
	7					75	46.3			54	192	192		R236	
	9					82	55.3			70	233	233		R258	
TN-320	6	355	255	100	18	66	44.3	105	95	44	167	256	102	R254	R210
	7					75	46.3			54	192	256		R271	
	9				82	55.3	70			233	286	R294			
	10				86	53.3	100			274	318	R303			
TN-450	12	425	425	0	25	92	59.3	170	150	110	310	318	136	R323	R375
	9					82	55.3			70	233	316		R213	
	10				86	53.3	100			274	336	R222			
	12				92	59.3	110			310	370	R244			
	15				30	100	70.3			150	385	445		R288	

Note 1: The above dimensions refer to power chucks by KOBAYASHI IRON WORKS CO., LTD.

Note 2: The flange type and the method of attaching the flange fixing bolt differ depending on the rotary table and the chuck size.

Example **P.31**

RBS

TBS

RWE/RWA
RN

RWE/RWA-B
RNCV-B

RNCM

RWB

RWB-K
RNCK

RCH
RNC

RCV
RNCV

Multi-Spindle
RWM

TWA/TN

TTNC

THNC

Multi-Spindle
TWM

RDS

RTV
RTT

RCB

NC Controllers

Accessories

Options

Technical
Information

Chuck

- RBS
- TBS
- RWE/RWA
RN
- RWE/RWA-B
RNCV-B
- RNCM
- RWB
- RWB-K
RNCK
- RCH
RNC
- RCV
RNCV
- Multi-Spindle
RWM
- TWA/TN
- TTNC
- THNC
- Multi-Spindle
TWM
- RDS
- RTV
RTT
- RCB
- NC Controllers
- Accessories
- Options
- Technical Information

Power chuck



Chuck size (inch)	Chuck type	Outer chucking range (mm)	Hydraulic cylinder type	Pneumatic cylinder type
4	H01MA 4	6 ~ 110	HH4C 63	H05CH100
5	H01MA 5	15 ~ 135	HH4C 63	H05CH150
6	H01MA 6	20 ~ 165	HH4C 80	H05CH200
8	H01MA 8	18 ~ 210	HH4C100	H05CH250
10	H01MA10	24 ~ 254	HH4C125	H05CH300

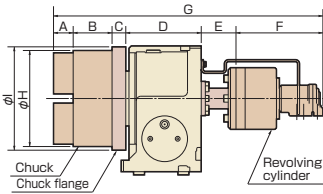

Example of pneumatic power chuck use



Hydraulic cylinder dimensions

Unit: mm

	Chuck size (inch)	A	B	C	D	E	F	G	H	I
RNCM-251	4	27	52	20	165	61	175	500	110	160
	5	27	52	20				500	135	185
	6	43	72	24				540	165	215
RNCM-301	6	43	72	24	220	36	175	570	165	225
	8		85	35		36	190	609	210	270
	10		95	35		39	197	629	254	315
RNCM-401	8	43	85	35	250	36	190	639	210	270
	10		95			39	197	659	254	315

Example P.19

Pneumatic cylinder dimensions

Unit: mm

	Chuck size (inch)	A	B	C	D	E	F	G	H	I
RBS-160	4	27	52	18	170	50	182	484	110	-
	5	27	52			64	190	506	135	
	6	43	72			64	200	552	165	
RBS-250	4	27	52	20	180	67	182	513	110	-
	5	27	52			64	190	518	135	
RBS-320	6	43	72	24	225	76	200	625	165	-
	8		85	35		243	695	210		
	10		95	35		258	717	254		
RWE/RWA-160	4	27	52	18	155	50	182	484	110	-
	5	27	52			64	190	506	135	
	6	43	72			64	200	552	165	
RWE/RWA-200 RWA-250	4	27	52	20	165	67	182	513	110	-
	5	27	52			64	190	518	135	
	6	43	72			64	200	564	165	
RWA-320	6	43	72	24	210	76	200	625	165	-
	8		85	35		243	692	210		
	10		95	35		258	717	254		
RNCM-251	4	27	52	20	165	67	182	513	110	160
	5	27	52	20		64	190	518	135	185
	6	43	72	24		64	200	568	165	215
RNCM-301	6	43	72	24	220	34	200	593	165	225
	8		85	35		39	243	665	210	270
	10		95	35		44	258	695	254	315
RNCM-401	8	43	85	35	250	39	243	695	210	270
	10		95			44	258	725	254	315

Note: The above dimensions refer to power chucks by HOWA MACHINERY, LTD. A front-mounting pneumatic chuck is also available.

Tailstock

Compatible Rotary Tables

NC Rotary Table	Tailstock type		
	Manual	Hydraulic	Pneumatic
RN-100	TL-110M	—	—
RWE/RWA-160	TL-135M	TLH-135	TLP-135
RBS-160 RWE/RWA-200, RWA-250 RNCM-251 RWB-250	TL-160M	TLH-160	TLP-160
RBS-250 RWA-320 RNCM-301 RWB-320	TL-210M	TLH-210	—
RBS-320 RNCM-401 RWB-400	TL-255M	TLH-255	—
RNCM-501	TL-310M	—	—
RNCM, RNCK-631	TL-400M	—	—
RCV-800	TL-530M	—	—
THNC-251	TL-210M	TLH-210	—
THNC-301	TL-235M	—	—

Order Code

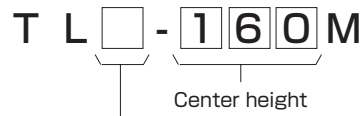

Alphabet	Type
No	Manual
H	Hydraulic
P	Pneumatic

Example



Manual Tailstock

TL-110M, 135M



TL-135M

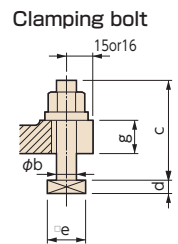
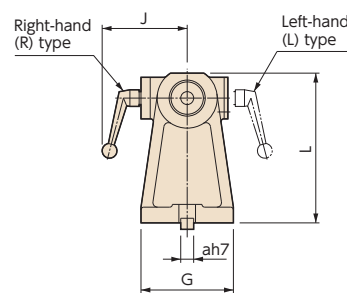
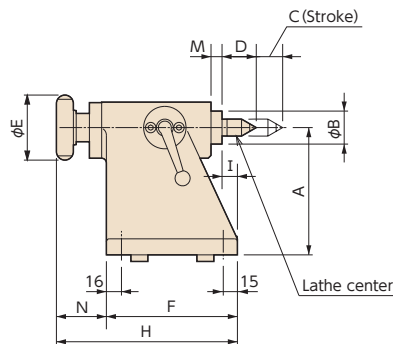

TL-□□□M



TL-160M

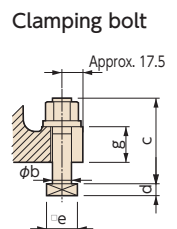
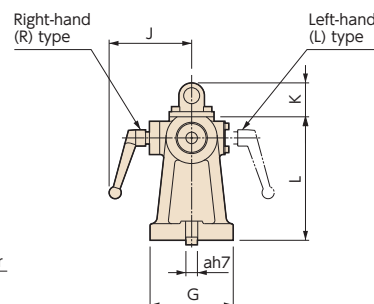
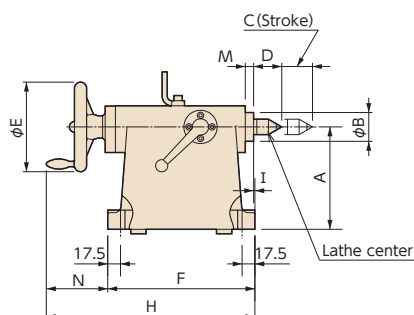

- RBS
- TBS
- RWE/RWA
RN
- RWE/RWA-B
RNCV-B
- RNCM
- RWB
- RWB-K
RNCK
- RCH
RNC
- RCV
RNCV
- Multi-Spindle
RWM
- TWA/TN
- TTNC
- THNC
- Multi-Spindle
TWM
- RDS
- RTV
RTT
- RCB

NC Controllers

Accessories

Options

Technical Information

Tailstock

- RBS
- TBS
- RWE/RWA
RN
- RWE/RWA-B
RNCV-B
- RNCM
- RWB
- RWB-K
RNCK
- RCH
RNC
- RCV
RNCV
- Multi-Spindle
RWM
- TWA/TN
- TTNC
- THNC
- Multi-Spindle
TWM

Dimensions

Unit: mm

Order Code	Morse taper	Center height A	Center dia B	Stroke C	Lathe center D	Handle dia E	Base dimensions F×G	H	I	J	K	L	M	N	a	b	c	d	e	g	Weight kg
TL-110M	MT2	110	35	28	36	69	139×100	192	16	92	—	137	12	53	14	12	55	8	23	20	8
TL-135M	MT2	135	35	28	36	69	139×100	192	16	92	—	162	12	53	14	12	55	8	23	20	9
TL-160M	MT3	160	45	48	44	140	230×130	326	2	129	53	193	13	96	18	16	75	11	28	30	22
TL-190M	MT3	190	45	48	44	140	230×140	326	2	129	53	223	13	96	18	16	75	11	28	30	24
TL-210M	MT3	210	45	48	44	140	230×146	326	2	129	53	243	13	96	18	16	75	11	28	30	26
TL-235M	MT4	235	50	53	52.5	160	270×160	383	12	131	53	270	8	113	18	16	80	11	28	35	30
TL-255M	MT4	255	50	53	52.5	160	270×170	383	12	131	53	290	8	113	18	16	80	11	28	35	38
TL-310M	MT4	310	60	53	52.5	180	315×220	417	15	154	65	350	10	102	18	16	85	11	28	40	63
TL-400M	MT4	400	60	53	52.5	180	315×240	417	15	154	65	440	10	102	18	16	85	11	28	40	76
TL-530M	MT4	530	80	68	52.5	225	410×290	532	30	164	65	590	5	122	22	20	95	13	32	40	138

Example



Hydraulic Tailstock

TLH-□□□□



TLH-160

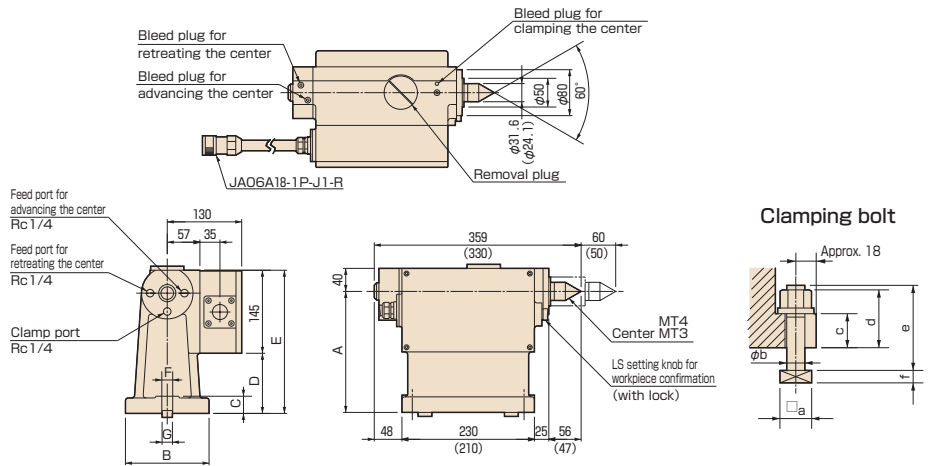

Note 1: Dimensions in parentheses are for the TLH-135.
 Note 2: Specify the cable length when placing an order.

Dimensions and specifications

Unit: mm

Order Code	A	B	C	D	E	F	Carbide center	Hydraulic MPa [kgf/cm ²]	Center thrust force N [kgf]	Center clamp torque [kgf]	Weight kg
TLH-135	135	110	25	30	175	19	MT3	1.5~6.8 [15~70]	1,670 [170]	2,450 [250]	28
TLH-160	160	130	30	55	200	19	MT4		2,352 [240]		33
TLH-210	210	146	30	105	250	19	MT4		2,352 [240]		36
TLH-255	255	170	35	150	295	19	MT4		2,352 [240]		40

* The table above shows the center thrust force and clamp torque when the hydraulic pressure is 3.5MPa (35kgf/cm²).

Clamping bolt dimensions

Unit: mm

Order Code	G	a	b	d	e	f
TLH-135	14	23	12	42	60	8
	16	26	16	46	70	10
	18	28	16	46	70	11
TLH-160 TLH-210	14	23	12	47	65	8
	16	26	16	51	75	10
TLH-255	18	28	16	51	75	11
	16	26	16	56	75	10
	18	28	16	56	80	11
	20	32	18	60	90	11

Support Spindle

Compatible Rotary Tables

Support spindle type NC Rotary Table	Support spindle type			
	No clamp	Pneumatic clamp	Hydraulic clamp	Strong hydraulic
RWE/RWA-160	TS-135	TS-135P	—	—
RBS-160 RWE/RWA-200 RWA-250 RNCM-251 RWB-250	TS-160	TS-160P	TSH-160	SSB-160
RBS-250 RWA-320 RNCM-301 RWB-320	TS-210	TS-210P	TSH-210	SSB-210
RWB-400	—	—	—	SSB-255
RWB-500	—	—	—	SSB-310

Order Code

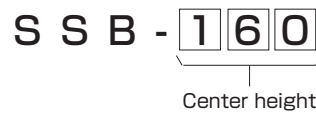
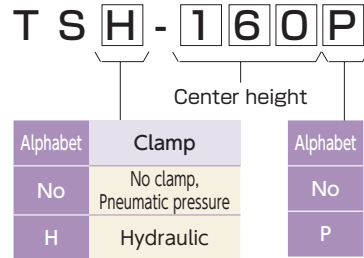

- RBS
- TBS
- RWE/RWA
RN
- RWE/RWA-B
RNCV-B
- RNCM
- RWB
- RWB-K
RNCK
- RCH
RNC
- RCV
RNCV
- Multi-Spindle
RWM
- TWA/TN
- TTNC
- THNC
- Multi-Spindle
TWM
- RDS
- RTV
RTT
- RCB
- NC Controllers
- Accessories
- Options
- Technical Information

TS-□□□ (No clamp)



TS-135

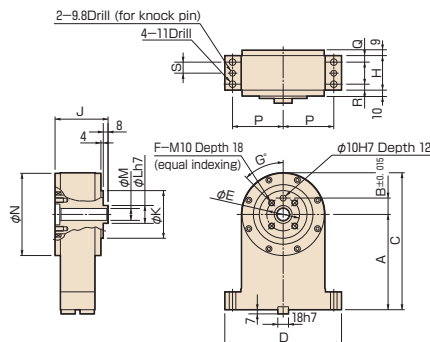

Example



Unit: mm

Order Code	A	B	C	D	E	F	G	H	J	K	L	M	N	P	Q	R	S	Weight kg
TS-135	135	27.5	205	196	55	4	45	58	89	80	30	20	138	85	11	10	18.5	13
TS-160	160	27.5	230	196	55	4	45	58	89	80	30	20	138	85	11	10	18.5	15
TS-210	210	37.5	295	226	75	6	30	67	101	100	50	40	168	100	11	11	22.5	29

TS-□□□P (Pneumatic clamp)



TS-160P

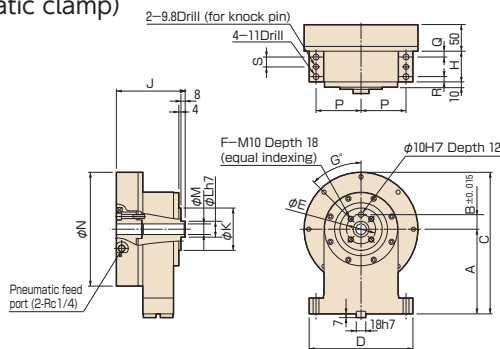

Example



Unit: mm

Order Code	A	B	C	D	E	F	G	H	J	K	L	M	N	P	Q	R	S	Clamping Torque (N·m) (0.49MPa)	Weight kg
TS-135P	135	27.5	218.5	196	55	4	45	58	130	80	30	20	167	85	11	10	18.5	156.9	20
TS-160P	160	27.5	267.5	196	55	4	45	58	130	80	30	20	215	85	11	10	18.5	383.7	27
TS-210P	210	37.5	337.5	226	75	6	30	67	141	100	50	40	255	100	11	11	22.5	779.1	45

Support Spindle

RBS

TBS

RWE/RWA
RN

RWE/RWA-B
RNCV-B

RNCM

RWB

RWB-K
RNCK

RCH
RNC

RCV
RNCV

Multi-Spindle
RWM

TWA/TN

TTNC

THNC

Multi-Spindle
TWM

RDS

RTV
RTT

RCB

NC Controllers

Accessories

Options

Technical
Information

TSH-□□□ (Hydraulic clamp)

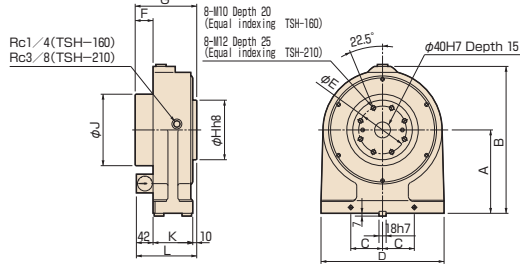

Example



Unit: mm

Order Code	A	B	C	D	E	F	G	H	J	K	L	Clamping Torque (N·m) (3.5MPa)	Weight kg
TSH-160	160	290	70	260	110	42	142	130	150	90	142	490	45
TSH-210	210	370	77	310	120	45	155	150	180	100	152	833	75

SSB-□□□

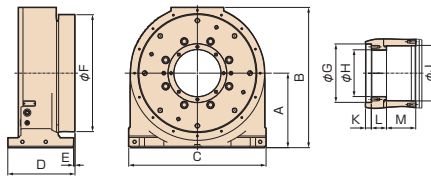

Unit: mm

Order Code	A	B	C	D	E	F	G	H	J	K	L	M	Clamping Torque (N·m)		Weight kg
													3.5MPa	4.9MPa	
SSB-160	160	303	290	175	5	250	105H7	80H7	95H8	15	42	66	1,300	2,000	60
SSB-210	210	396	380	210	5	320	150H7	120H7	145H8	15	50	90	3,100	4,700	120
SSB-255	255	480	470	230	5	400	200H7	160H7	190H8	20	52	100	5,500	8,000	185
SSB-310	310	560	470	230	5	500	200H7	160H7	190H8	20	52	100	5,500	8,000	230

Face Plate

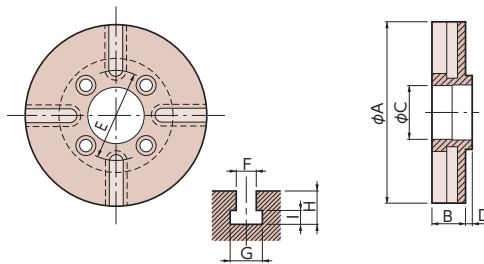

Unit: mm

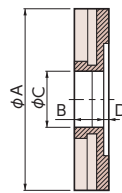

For RN-100
TBS-160
TWA-160, TWA-200

	A Face plate diamete	B	C	D	E	F	G	H	I
RN-100	135	25	φ50H7	5	φ68	10H8	16 ⁺² ₀	17	7 ⁺¹ ₀
RBS-160 RWE/RWA-160	160 200	30	φ50H7	3	φ75	12H8	19 ⁺² ₀	19	8 ⁺¹ ₀
RWE/RWA-200	200 250	30	φ60H7	3	φ90	12H8	19 ⁺² ₀	19	8 ⁺¹ ₀
RBS-250 RWA-250	250	30	φ75H7	5	φ110	12H8	19 ⁺² ₀	19	8 ⁺¹ ₀
RBS-320 RWA-320	320	40	φ110H7	5	φ140	14H8	23 ⁺² ₀	23	9 ⁺¹ ₀
TBS-130	135	25	φ40H7	5	φ70	12H8	19 ⁺² ₀	19	8 ⁺¹ ₀
TBS-160	160 200	25	φ50H7	5	φ75	12H8	19 ⁺² ₀	19	8 ⁺¹ ₀
TBS-250	250	30	φ75H7	5	φ110	12H8	19 ⁺² ₀	19	8 ⁺¹ ₀
TWA-100	135	25	φ40H7	5	φ70	12H8	19 ⁺² ₀	19	8 ⁺¹ ₀
TWA-130	135	25	φ40H7	5	φ70	12H8	19 ⁺² ₀	19	8 ⁺¹ ₀
TWA-160	160 200	25	φ50H7	5	φ75	12H8	19 ⁺² ₀	19	8 ⁺¹ ₀
TWA-200	200 250	30	φ60H7	5	φ90	12H8	19 ⁺² ₀	19	8 ⁺¹ ₀

Example



High-precision Specification by Rotary Encoders or MP Scales

Indexing accuracy can be upgraded by attaching a rotary encoder or MP scale to the spindle of the rotary table. The sum of the cumulative indexing accuracy of the rotary encoder or the MP scale and electrically divided errors of the pre-amplifier or the waveform shaping unit is referred to as the indexing accuracy of the rotary tables with scales. The indexing accuracy is guaranteed by TSUDAKOMA.

Model Description

"RNCM-□□□R,□□"

RE (Rotary encoders)

RI (MP scales)

Example of measurement indexing accuracy with scale

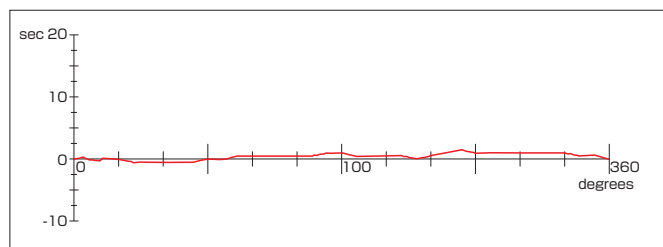

Rotary encoder

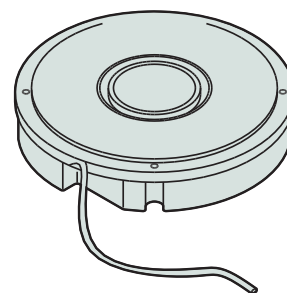

MP scale

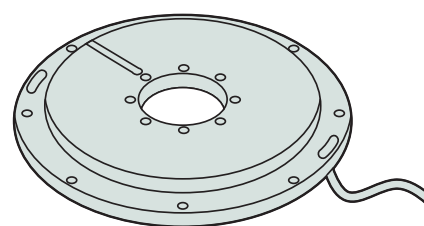

Indexing accuracy with scale

		Rotary encoders		MP scales	
		Order Code	Accuracy with scale	Order Code	Accuracy with scale
RBS-160 RWE/RWA-160 RWE/RWA-200	Rotary axis	RCN23*0 or RU77-4096A	15sec	MPI 536A	15sec
RBS-250, 320 RWA-250 RWA-320	Rotary axis	RCN83*0, RCN85*0 or RS97-1024	10sec/RCN83*0, RS97-1024 6sec/RCN85*0	MPI 736B	10sec
RNCM-251, 301 RWB-250, RWB-250K RWB-320, RWB-320K	Rotary axis	RCN83*0, RCN85*0 or RS97-1024	10sec/RCN83*0, RS97-1024 6sec/RCN85*0	MPI 736B	10sec
RWB-400, RWB-400K RWB-500, RWB-500K RWB-630 RNCM-401~631 RNCK-631 RNCV-1501	Rotary axis			MPI 1072B	8sec
TWA-130	Rotary axis* Tilt axis	RCN23*0 or RU77-4096A	15sec	MPI 536A	15sec
TWA-160	Rotary axis Tilt axis				
TWA-200	Rotary axis Tilt axis				
TBS-130	Rotary axis* Tilt axis				
TBS-160	Rotary axis Tilt axis	RCN23*0 RCN83*0, RCN85*0 or RU77-4096A RS97-1024	15sec/RCN23*0, RU77-4096A 10sec/RCN83*0, RS97-1024 6sec/RCN85*0	MPI 736B	10sec
TBS-250	Tilt axis				
TN-320	Rotary axis Tilt axis	RCN83*0, RCN85*0 or RS97-1024	10sec/RCN83*0, RS97-1024 6sec/RCN85*0	MPI 736B	10sec
TN-450	Rotary axis Tilt axis			MPI 1072B	10sec
TTNC-631	Rotary axis	RCN83*0, RCN85*0 or RS97-1024	10sec/RCN83*0, RS97-1024 6sec/RCN85*0	MPI 1272B	8sec
TTNC-1001	Tilt axis			MPI 736B	10sec
	Tilt axis			MPI 736B	15sec
	Rotary axis			MPI 1272B	8sec
	Tilt axis			MPI 1272B	15sec

☞ For other accuracy standard. P.71 ~

Accuracy differs depending on the specifications of the tables. Ask us for further information.
Note: With rotary encoder or MP scale, TWA/TN series change their center height.

*Rotary encoders are unavailable.

- RBS
- TBS
- RWE/RWA
RN
- RWE/RWA-B
RNCV-B
- RNCM
- RWB
- RWB-K
RNCK
- RCH
RNC
- RCV
RNCV
- Multi-Spindle
RWM
- TWA/TN
- TTNC
- THNC
- Multi-Spindle
TWM
- RDS
- RTV
RTT
- RCB
- NC Controllers
- Accessories
- Options
- Technical Information

High-precision Specification by Rotary Encoders or MP Scales

Specifications of rotary encoders

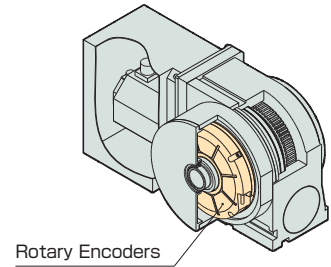
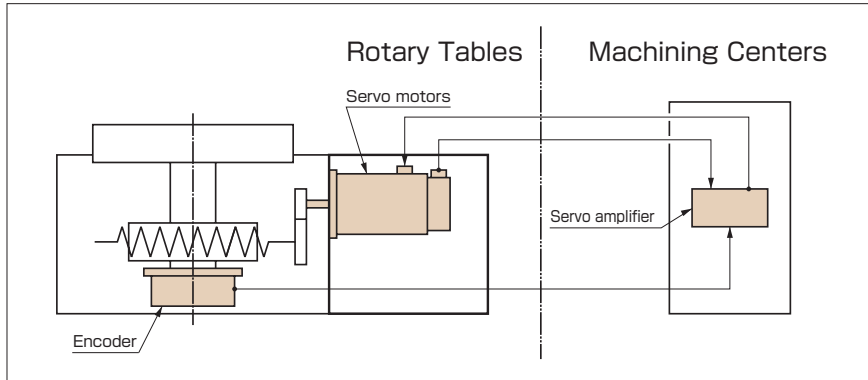



HEIDENHAIN

Rotary Encoders	RON886	RCN23*0	RCN83*0	RCN85*0
Interface unit	IBV102	Not required	Not required	Not required
Recommended resolution	0.0005°	26bit ABS	29bit ABS	29bit ABS

Model RCN and corresponding Interface

RCN 23  0 

Interface		
FANUC	9	F
MITSUBISHI ELECTRIC	9	M
EnDat 2.2	1	—

Magnescape

Rotary Encoders	RU77-4096A	RS97-1024
Recommended resolution	23bit ABS	23bit ABS

Model RU77 and corresponding Interface

RU77-4096A  G

Interface	
FANUC	A
MITSUBISHI ELECTRIC	D
YASKAWA ELECTRIC	F

Model RS97 and corresponding Interface

RS97-1024EG 

Interface	
FANUC	A
MITSUBISHI ELECTRIC	D

Specifications of MP scales (by Mitsubishi Heavy Industries)

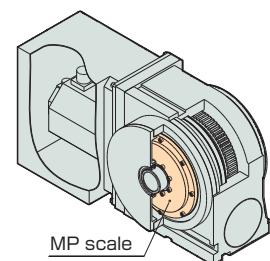
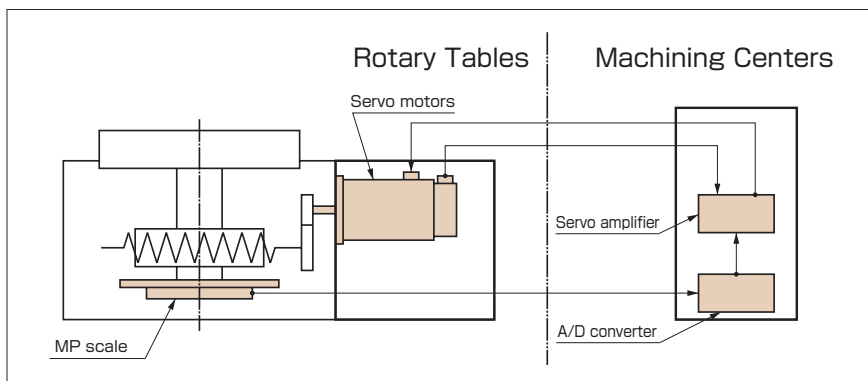

MP scale	MPI 536A	MPI 736B	MPI 1072B	MPI 1272B
Recommended resolution	0.0001°	0.0001°	0.00005°	0.00005°
A/D converter	ADB-20J10			

Note 1:AD converter (corresponding to the serial output interface) is necessary in the MPRZ series.

Note 2:Preamplifiers are necessary for MPR-series.

Note 3:When using preamplifiers for MPR-series other than those of MHI Machine Tool Engineering, consult us.

Pull Stud

A unit to position and fix a fixture and a workpiece on the rotary table by using the taper shank with a pull stud. This unit can be combined with a robot or a work loader to create an unmanned machining system.

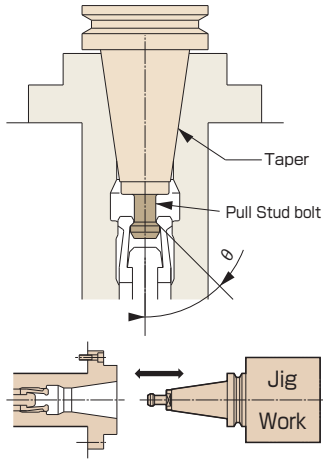

* With clamp/unclamp confirmation switch

Applicable models and specifications Unit: mm

Order Code	Taper shank	Pull stud clamp force N [kgf]	Hydraulic pressure MPa [kgf/cm ²]	Pneumatic pressure for air blow MPa [kgf/cm ²]
RWB-250	BT-50	11,000 [1,122]	3.5 [35]	0.2~0.4 [2~4]
RWB-250K				
TWA-200				
TN-320				
RWB-320	BT-50	15,000 [1,530]	3.5 [35]	0.2~0.4 [2~4]
RWB-320K				
RWB-400				
RWB-400K				
RWB-500				
RWB-500K				

Specify the pull stud type.

Taper	Pull stud type	
	θ	
BT-50	45°	I
	60°	II
	90°	Others

Rotary Joint

A rotary joint unit to supply hydraulic or pneumatic pressure to workpieces or actuators mounted on the rotary tables. Automatic loading and unloading of workpieces are possible.

Applicable models and specifications Unit: mm

Order Code	Size	Max. number of ports	Rated supplied pressure MPa [kgf/cm ²]
RBS RWE/RWA	160	6	3.5 [35]
	200	6	
	250	6	
RNCM	320	8	
	251	6	
	301	6	
	401	6	
RWB	501	8	
	250	10	
	320	12	
	400	16	
	500	16	
RNCK	630	16	
	631	12	
TBS	130	6	
	160	6	
	250	6	
TWA	130	6	
	160	6	
	200	6	

External mount type



Internal mount type

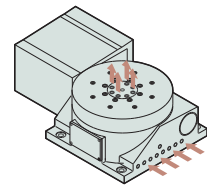

Example of use

Compact Rotary Joint

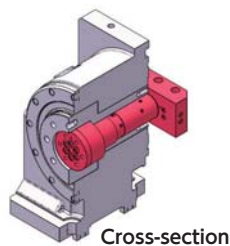
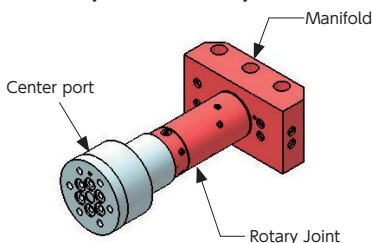

[Specifications]

Max. number of ports: 6 port
Rated supplied pressure: 21.0MPa [210kgf/cm²]

[Applicable models]

Correspond to the models which have more than $\phi 40$ center through hole.
RBS, RWE/RWA, TBS, TWA Series.

RBS

TBS

RWE/RWA
RN

RWE/RWA-B
RNCV-B

RNCM

RWB

RWB-K
RNCK

RCH
RNC

RCV
RNCV

Multi-Spindle
RWM

TWA/TN

TTNC

THNC

Multi-Spindle
TWM

RDS

RTV
RTT

RCB

NC Controllers

Accessories

Options

Technical Information

Pallet Clamp

An NC rotary table with a built-in pallet clamp is available. This type of rotary table enables fast and highly accurate positioning of workpieces at any angle. Attachment of an auto-coupler makes it possible to apply hydraulic or pneumatic pressure to the top surface of pallets. By combining with a pallet-changer, setup, transfer and exchange can be carried out automatically.

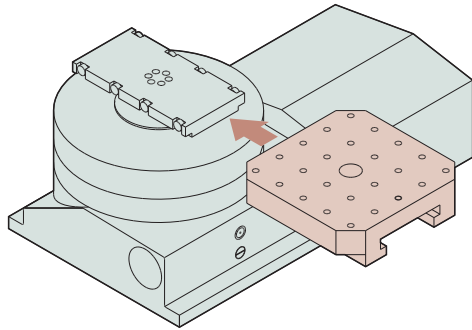

Air-hydraulic Booster

Air-hydraulic boosters are available for machines without a hydraulic source, which convert pneumatic pressure into hydraulic pressure for clamping.

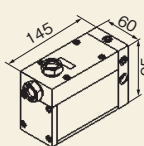
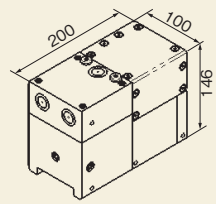
Type	Applicable model	Dimensions
TB-50	RNCM-251	
TB-80	RNCM-301 RNCM-401 RNCM-501 RWB-250 RWB-250 + SSB-160 RWB-320 RWB-400	

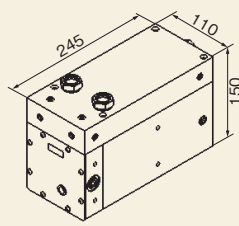
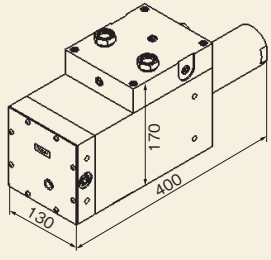
Type	Applicable model	Dimensions
TB-100	RWB-320 + SSB-210 RWB-400 + SSB-255 RWB-500 RWB-500 + SSB-310 RCH/RCV-800	
TB-115	RCH/RCV-1000 RCH/RCV-1250	

Mounting position

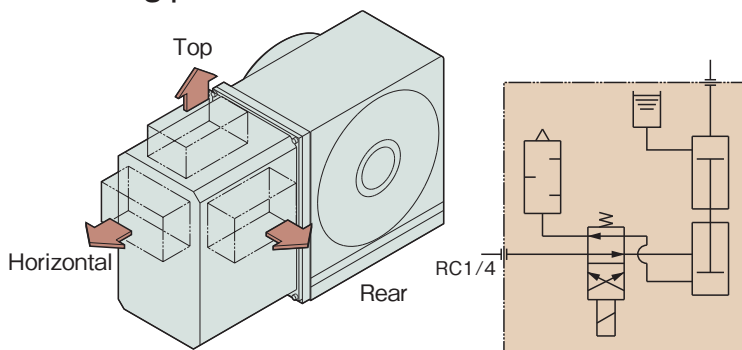

Please specify the following items:

1. Mounting position of the Air-hydraulic booster
2. Control voltage for the solenoid of the Air-hydraulic unit: AC100V or DC24V (This voltage depends on the machine to be attached)

Explanation of Technical Terms

In order to help you understand Tsudakoma's products, here are some explanations about the main specifications.

Indexing Accuracy

After indexing one rotation of the table equally according to the tooth number of the worm gear, obtain the difference between the theoretical turning angle and the measured angle. The indexing accuracy is the sum of the maximum difference in positive values and that in negative values (absolute values).

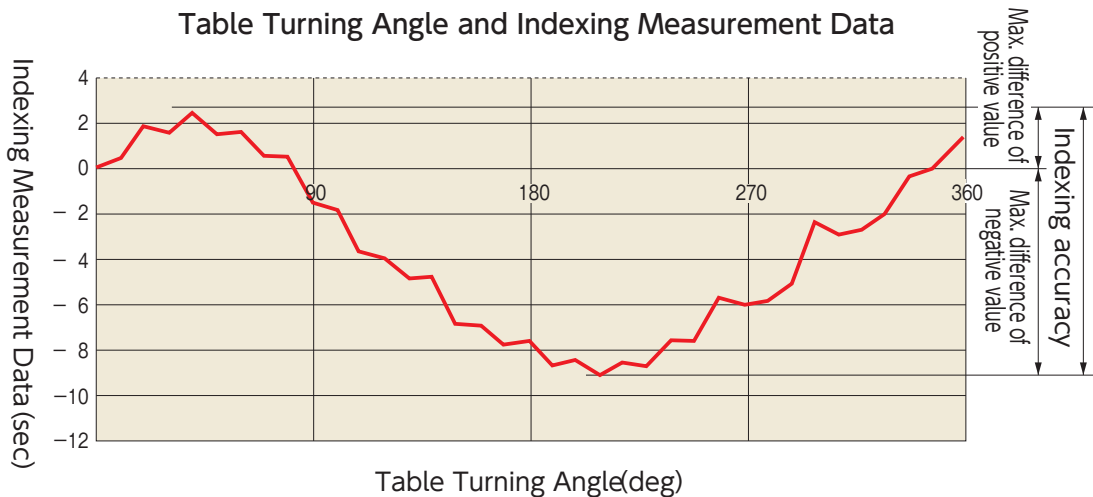

Clamp Torque

Clamp torque is only the force of the clamping mechanism, which does not include force caused by self-locking of a worm gear. The clamp torque shown in the catalog is the figure obtained when the rated pressure (3.5 MPa for hydraulic pressure, and 0.49 MPa for pneumatic pressure) is supplied to the working fluid. When a larger clamp torque is required, increase the pressure gradually up to the maximum allowable pressure (4.9 MPa for hydraulic pressure, 0.69 MPa for pneumatic pressure) to increase the clamp torque.

Worm Gear Strength

Worm gear strength is the allowable wheel torque when table rpm is 1 min-1. The allowable torque for the worm wheel is calculated according to the standards stipulated by the Japan Gear Manufacturers Association.

RBS

TBS

RWE/RWA
RN

RWE/RWA-B
RNCV-B

RNCM

RWB

RWB-K
RNCK

RCH
RNC

RCV
RNCV

Multi-Spindle
RWM

TWA/TN

TTNC

THNC

Multi-Spindle
TWM

RDS

RTV
RTT

RCB

NC Controllers

Accessories

Options

Technical Information

Applicable Servo Motors

FANUC α i type servo motors are specified for each NC table model in the specifications table. The table below shows other servo motors, which have equivalent capacity to those of FANUC α i motors.

FANUC	α iF2/5000 (α iS2/5000)	α iF4/5000 (α iS4/5000)	α iF8/3000 (α iS8/4000)	α iF12/4000 (α iS12/4000)	α iF22/3000 (α iS22/4000)
MITSUBISHI	HF75T	HF54T	HF104T	HF204S	HF354S
YASKAWA	SGMPS-04	SGMGV-05	SGMGV-09	SGMGV-20	SGMGV-30
OKUMA	BL-ME24MJ BL-ME24M	BL-ME40MJ BL-ME40M	BL-ME80MJ BL-ME80M	BL-ME150MJ BL-ME150M	BL-ME200MJ BL-ME200M
SIEMENS	1FK7042	1FK7060	1FK7063	1FK7083	1FK7101
HEIDENHAIN	QSY96A	QSY116C	QSY116E	QSY155B	QSY155D

Note 1: Some motors have speed reduction ratio (max rpm) or outline dimensions different from those of FANUC motors.
 Note 2: The motors shown above are classified according to motor torque capacity. The motor which is suitable for your machines depends on the specifications of your machine NC controllers. Contact the machine manufacturer about motor selection.

Applicable Cable Connectors

All cable plugs and connectors for Tsudakoma's NC rotary tables should be waterproof. Refer to the table below.

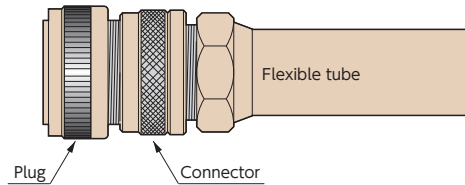

Example of cable plug connectors

	Rotary table receptacle	Cable plug	Connector	Flexible tube
For signal cable	N/MS3102A20-29PW (Japan Aviation Electronics Industry, Ltd.)	JA06A20-29SW-J1-R (Japan Aviation Electronics Industry, Ltd.)	KMKD22-20 (SANKEI MANUFACTURING CO.,LTD.) MSA22-20 (DAIWA DENGYO CO.,LTD.)	KPF-22 (SANKEI MANUFACTURING CO.,LTD.) FCV-22 (DAIWA DENGYO CO.,LTD.)
	N/MS3102A22-14 (Japan Aviation Electronics Industry, Ltd.)	JA06A22-14S-J1-R (Japan Aviation Electronics Industry, Ltd.)	KMKD22-22 (SANKEI MANUFACTURING CO.,LTD.) MSA22-22 (DAIWA DENGYO CO.,LTD.)	FCV-28 (DAIWA DENGYO CO.,LTD.)
For power cable	N/MS3102A28-11P (Japan Aviation Electronics Industry, Ltd.)	JA06A28-11S-J1-R (Japan Aviation Electronics Industry, Ltd.)	KMKD28-28 (SANKEI MANUFACTURING CO.,LTD.) MSA28-28 (DAIWA DENGYO CO.,LTD.)	FCV-28 (DAIWA DENGYO CO.,LTD.)

Example of cable plug connectors (with a FANUC α iF motor) P.76

	Rotary table receptacle	Cable plug	Connector	Flexible tube
For signal cable	N/MS3102A20-29PW (Japan Aviation Electronics Industry, Ltd.)	JA06A20-29SW-J1-R (Japan Aviation Electronics Industry, Ltd.)	NBKD-20-20 (SANKEI MANUFACTURING CO.,LTD.)	NSBS# 20 (SANKEI MANUFACTURING CO.,LTD.)
For power cable	JL04V-2A28-11PE-R (Japan Aviation Electronics Industry, Ltd.)	JL04V-6A28-11SE-R (Japan Aviation Electronics Industry, Ltd.)	NBKD-32-28 (SANKEI MANUFACTURING CO.,LTD.)	NSBS# 32 (SANKEI MANUFACTURING CO.,LTD.)

Note: JA06A□□ plug is waterproof when the plug is inserted.

Flow Chart of Control System

It is recommended to control Tsudakoma's NC rotary tables with the servo motor ON. The following are recommended flow charts.

a) Semi-closed loop control

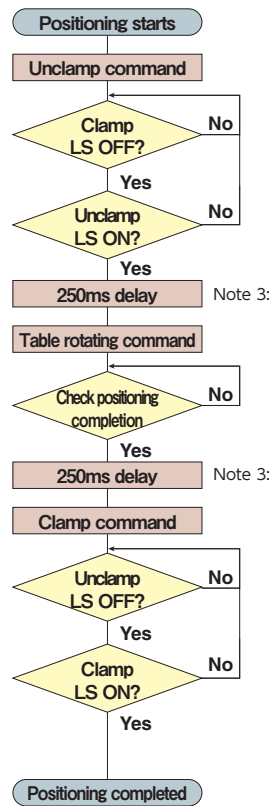

b) Fully-closed loop control

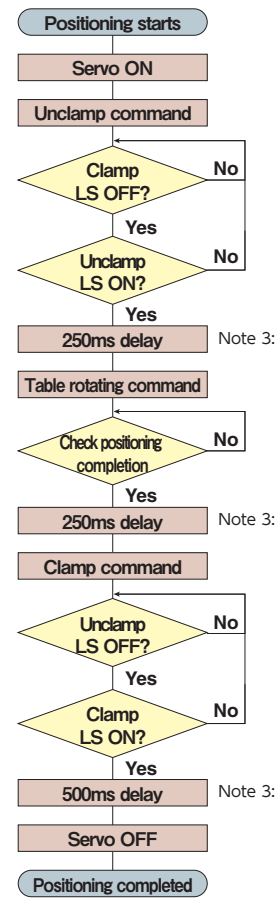

Note 1: In a semi-closed loop control operation, do not turn the Servo motor OFF even when the rotary table is clamped.

Note 2: In a semi-closed operation, when the eccentric load increases in size, and a large current (70% or more of the rated current) is being applied, turn the Servo motor OFF and follow the steps for the full-closed loop control.

Note 3: Delay time is our recommended time. Parameters may differ depending on the specifications. Ask us for further information.

Indexing Cycle Time

The graphs below show the required indexing time which includes the time for the control command for the machine tools. This information helps you examine the cycle time of your process with the rotary table. Table rotation speed and acceleration and deceleration constants may differ depending on the model of the rotary table. If any data other than that shown below is required, please ask us.

- A** : Without clamp command
 - B** : For hydraulic clamp (0.4Sec)
 - C** : For pneumatic clamp (0.6Sec)
 - D** : For air-hydraulic clamp (1.0Sec)
- ※ () shows Clamp & Un-clamp required time

Table rpm 8000deg/min (22.2min⁻¹)
Acceleration/deceleration constant : 150ms

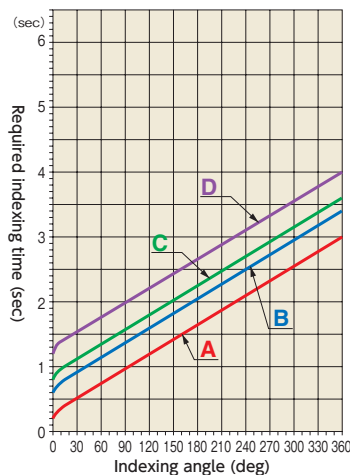
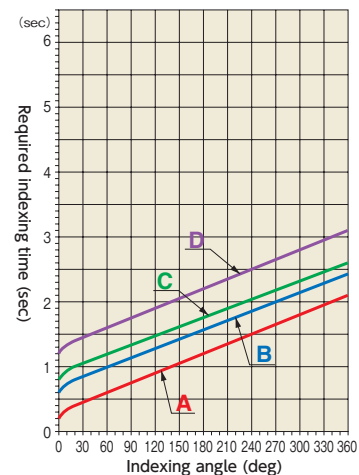

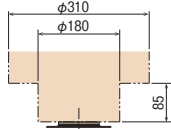
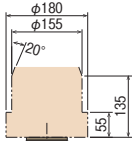

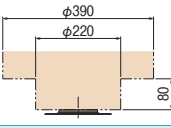
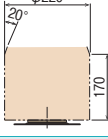

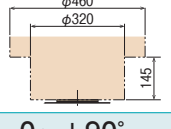
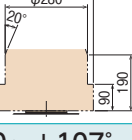

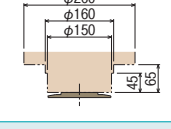
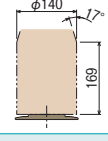

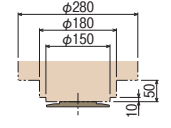
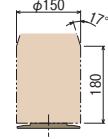

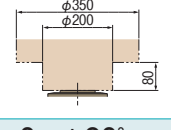
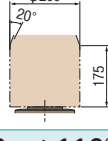

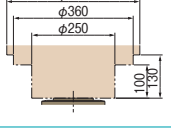
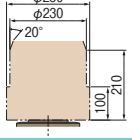

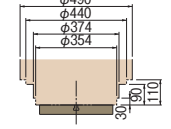
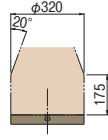

Table rpm 12000deg/min (33.3min⁻¹)
Acceleration/deceleration constant : 150ms



Note: For the above B and C cases, the indexing time includes the time to respond to the clamp and unclamp confirmation signals.

- RBS
- TBS
- RWE/RWA/RN
- RWE/RWA-B/RNCV-B
- RNCM
- RWB
- RWB-K/RNCK
- RCH/RNC
- RCV/RNCV
- Multi-Spindle RWM
- TWA/TN
- TTNC
- THNC
- Multi-Spindle TWM
- RDS
- RTV/RTT
- RCB
- NC Controllers
- Accessories
- Options
- Technical Information

Workpiece mounting space for tilting rotary tables

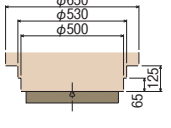
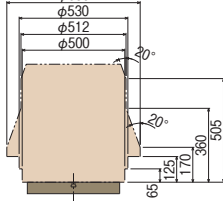
RBS			
TBS			
RWE/RWA RN			
RWE/RWA-B RNCV-B			
RNCM			
RWB			
RWB-K RNCK			
RCH RNC			
RCV RNCV			
Multi-Spindle RWM			
TWA/TN			
TTNC			
THNC			
Multi-Spindle TWM			
RDS			
RTV RTT			
RCB			
NC Controllers			
Accessories			
Options			
Technical Information			
TBS-130	0~+90° 	0~+110° 	-30°~0 
TBS-160	0~+90° 	0~+110° 	-30°~0 
TBS-250	0~+90° 	0~+110° 	-30°~0 
TWA-100	0~+90° 	0~+107° 	-17°~0 
TWA-130	0~+90° 	0~+107° 	-17°~0 
TWA-160	0~+90° 	0~+110° 	-30°~0 
TWA-200	0~+90° 	0~+110° 	-30°~0 
TN-320	0~+90° 	0~+110° 	-30°~0 
TN-450	-10°~+95° 	-15°~+100° 	
		※Emergency stop angle Loading area is set taking the inertia of 10° from the emergency stop position into consideration.	

Note 1: If the tilting angle is over the above range or the table stops by emergency stop, check the unit.
 Note 2: Be sure to remove the eye bolts used for lifting before using the rotary table.

To make the best use of TSUDAKOMA NC rotary tables

1 First of all, determine the NC controller system that best controls the NC rotary tables.

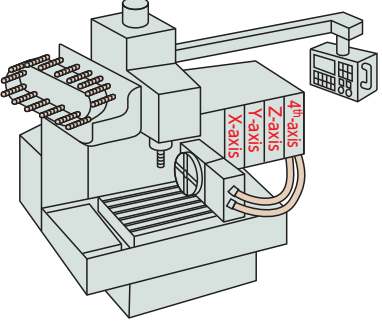
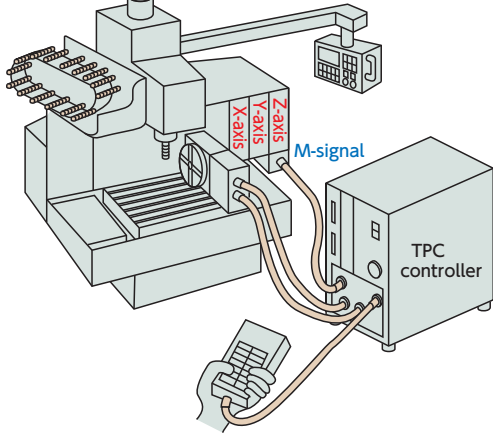
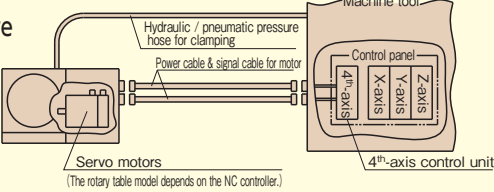
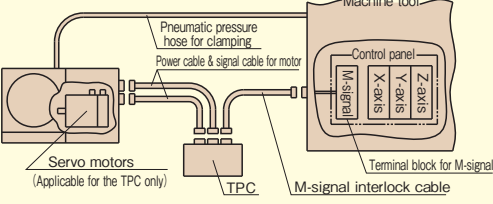
NC control system 1	NC control system 2
<p>A control unit for the 4th axis (or 5th axis) should be installed in the NC controller of the machine tool.</p>	<p>The TPC single axis NC controller of TSUDAKOMA is applied, receiving an M-signal from the machine tool.</p>
	
<p>Structure</p> 	<p>Structure</p> 
<p>Features</p> <ul style="list-style-type: none"> • Simultaneous and continuous circular cutting on the X, Y, and Z-axes is possible depending on the specifications of the machine tool. • The program of the rotary table should be input at the machine tool. 	<p>Features</p> <ul style="list-style-type: none"> • Even if the 4th (or 5th) axis cannot be installed on a machine tool, the TPC controller can be used with an M-signal. • Basically, this control system is only for indexing. • Program for a rotary table should be input directly to the TPC. At the machine tool, an M-signal is input as a start command.

2 Please select the most suitable model of NC rotary tables, depending on the workpiece and cutting conditions.

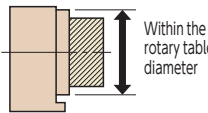
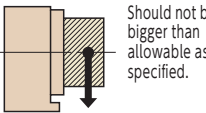
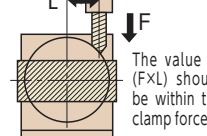
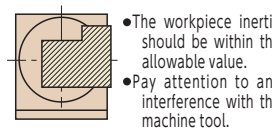
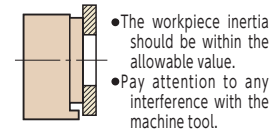
<p>• Workpiece diameter</p>  <p>Within the rotary table diameter</p>	<p>• Workpiece weight</p>  <p>Should not be bigger than allowable as specified.</p>	<p>• Workpiece positioning</p>  <p>The value of (FXL) should be within the clamp force.</p>	<p>• When an eccentric load is applied:</p>  <ul style="list-style-type: none"> • The workpiece inertia should be within the allowable value. • Pay attention to any interference with the machine tool. 	<p>• Workpiece of larger diameter, but lighter weight</p>  <ul style="list-style-type: none"> • The workpiece inertia should be within the allowable value. • Pay attention to any interference with the machine tool.
--	---	---	---	--

3 Please select the handedness of the NC rotary tables.

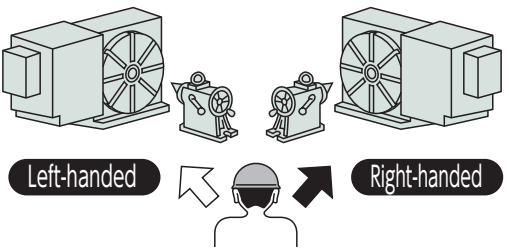

Left-handed **Right-handed**

Please take interference with the automatic tool changer (ATC) and easy operation into consideration when you make your selection.

4 Please take interference with a machining center into consideration when selecting a table.

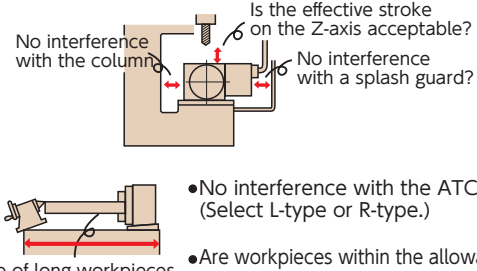

- Is the effective stroke on the Z-axis acceptable?
- No interference with the column?
- No interference with a splash guard?
- No interference with the ATC? (Select L-type or R-type.)
- Are workpieces within the allowable load of the table?

In the case of long workpieces, check that the workpiece length is within the table length.

- RBS
- TBS
- RWE/RWA/RN
- RWE/RWA-B/RNCV-B
- RNCM
- RWB
- RWB-K/RNCK
- RCH/RNC
- RCV/RNCV
- Multi-Spindle/RWM
- TWA/TN
- TTNC
- THNC
- Multi-Spindle/TWM
- RDS
- RTV/RTT
- RCB
- NC Controllers
- Accessories
- Options
- Technical Information

If you need our help to select the best model for you:

Inform TSUDAKOMA of the information below, and TSUDAKOMA will suggest the best model for you.

Fill in this page and send it to a local distributor or TSUDAKOMA. Fax : +81-76-294-5157

1. Customer _____ Tel _____
2. Model considering _____ Unit _____
3. Machine Manufacturer _____
 Model _____ (New • Installed)
 NC controller _____
4. Coolant oil Not used Used (Oil • Water) (Normal • High Pressure)
5. Workpiece Kind _____ Material _____ Weight _____
 Dimensions Height (_____) × Length (_____) × Width (_____) mm
 Inner dia (_____) × Outer dia (_____) × Length (_____) mm

6. Layout of workpiece and fixture (Write the detailed dimensions from the top surface or the center of the face plate)

	<p style="text-align: center;">Example</p>
--	--

7. Cutting conditions

Cutting point	Cutter / teeth number	Cutting speed (V)	Cutting feed rate mm/min	Cutting depth mm/time	Cutting process (Indexing or continuous cutting)
a					
b					
c					
d					

- RBS
- TBS
- RWE/RWA
RN
- RWE/RWA-B
RNCV-B
- RNCM
- RWB
- RWB-K
RNCK
- RCH
RNC
- RCV
RNCV
- Multi-Spindle
RWM
- TWA/TN
- TTNC
- THNC
- Multi-Spindle
TWM
- RDS
- RTV
RTT
- RCB
- NC Controllers
- Accessories
- Options
- Technical Information**

Inspection Standard

NC Rotary Tables

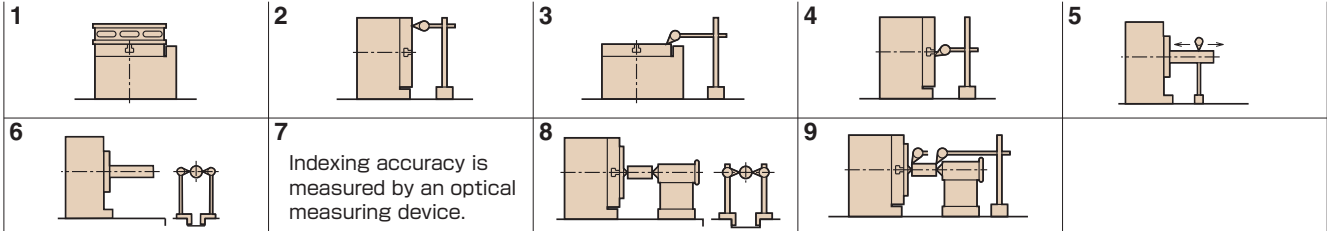

RBS

Unit: mm

No.	Inspection items			Tolerance					
				RBS-160		RBS-250		RBS-320	
				Standard	With a scale	Standard	With a scale	Standard	With a scale
2	Spindle top runout	—	—	0.01	0.01	0.01	0.01	0.01	0.01
3	Parallelism top to frame bottom	Per 200mm	Horizontal	0.02	0.02	0.02	0.02	0.02	0.02
4	Center bore runout	Spindle nose	—	0.01	0.01	0.01	0.01	0.01	0.01
5	Parallelism of rotary axis center line to frame bottom	Per 200mm	Vertical	0.02	0.02	0.02	0.02	0.02	0.02
6	Parallelism of rotary axis center line to guide blocks	Per overall length	Vertical	0.02	0.02	0.02	0.02	0.02	0.02
7	Indexing accuracy (arc sec.)	Cumulative	—	15 15	15 10	15 10	15 10	15 10	15 10
8	Parallelism of center line between rotary table and tailstock to frame bottom guide blocks	Per 300mm	Vertical	0.02	0.02	0.02	0.02	0.02	0.02
9	Height difference of both center lines of rotary table and tailstock	—	Vertical	0.02	0.02	0.02	0.02	0.02	0.02

Note: The indexing accuracy above is for tables with MP scales. See P.61 for indexing accuracy of HEIDENHAIN rotary encoders.

RWE/RWA

Unit: mm

No.	Inspection items			Tolerance							
				RWE/RWA-160		RWE/RWA-200		RWA-250		RWA-320	
				Standard	With a scale	Standard	With a scale	Standard	With a scale	Standard	With a scale
2	Spindle top runout	—	—	0.01	0.01	0.01	0.01	0.01	0.01	0.01	0.01
3	Parallelism top to frame bottom	Per 200mm	Horizontal	0.02	0.02	0.02	0.02	0.02	0.02	0.02	0.02
4	Center bore runout	Spindle nose	—	0.01	0.01	0.01	0.01	0.01	0.01	0.01	0.01
5	Parallelism of rotary axis center line to frame bottom	Per 200mm	Vertical	0.02	0.02	0.02	0.02	0.02	0.02	0.02	0.02
6	Parallelism of rotary axis center line to guide blocks	Per overall length	Vertical	0.02	0.02	0.02	0.02	0.02	0.02	0.02	0.02
7	Indexing accuracy (arc sec.)	Cumulative	—	25 15	20 15	20 10	20 10	20 10	20 10	20 10	20 10
8	Parallelism of center line between rotary table and tailstock to frame bottom guide blocks	Per 300mm	Vertical	0.02	0.02	0.02	0.02	0.02	0.02	0.02	0.02
9	Height difference of both center lines of rotary table and tailstock	—	Vertical	0.03	0.03	0.03	0.03	0.03	0.03	0.03	0.03

Note: The indexing accuracy above is for tables with MP scales. See P.61 for indexing accuracy of HEIDENHAIN rotary encoders.

RWB

Unit: mm

No.	Inspection items			Tolerance					
				RWB-250,320		RWB-400,500		RWB-630	
				Standard	With a scale	Standard	With a scale	Standard	With a scale
1	Table top flatness (concave)	Per overall length	—	0.01	0.01	0.02	0.01	0.03	0.01
2	Table top runout	—	—	0.015	0.01	0.015	0.01	0.02	0.01
3	Parallelism of table top to frame bottom	Per overall length	Horizontal	0.02	0.01	0.02	0.01	0.03	0.02
4	Center bore runout	Spindle nose	—	0.01	0.005	0.01	0.005	0.01	0.01
5	Parallelism of rotary axis center line to frame bottom	Per 300mm	Vertical	0.02	0.01	0.015	0.01	0.015	0.01
6	Parallelism of rotary axis center line to guide blocks	Per 300mm	Vertical	0.02	0.01	0.015	0.01	0.015	0.015
7	Indexing accuracy (arc sec.)	Cumulative	—	14	8	14	8	14	8
8	Parallelism of center line between rotary table and tailstock to frame bottom guide blocks	Per 300mm	Vertical	0.02	0.01	0.02	0.01	0.02	0.01
9	Height difference of both center lines of rotary table and tailstock (tailstock center line should be higher)	—	Vertical	0.02	0.01	0.02	0.01	0.02	0.01

Note1: The indexing accuracy above is for tables with MP scales. See P.61 for indexing accuracy of HEIDENHAIN rotary encoders.

Note2: For RWB-K, No.3 is not required.

RBS

TBS

RWE/RWA
RN

RWE/RWA-B
RNCV-B

RNCM

RWB

RWB-K
RNCK

RCH
RNC

RCV
RNCV

Multi-Spindle
RWM

TWA/TN

TTNC

THNC

Multi-Spindle
TWM

RDS

RTV
RTT

RCB

NC Controllers

Accessories

Options

Technical
Information

Inspection Standard

NC Rotary Tables

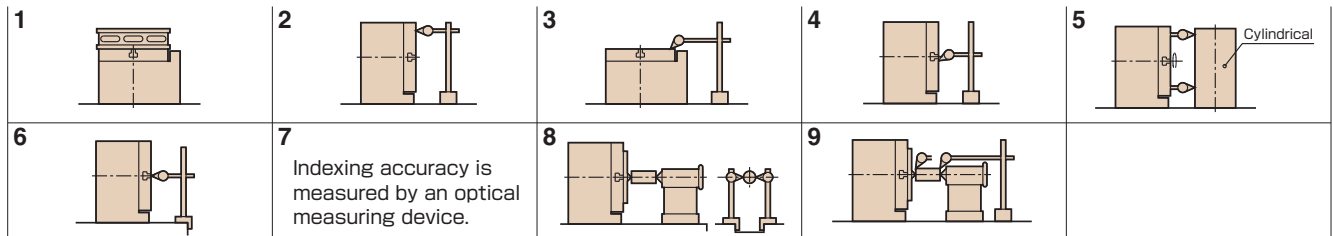

RN

Unit: mm

No.	Inspection items	Tolerance		
		RN-100		
2	Spindle top runout	—	—	0.01
3	Parallelism top to frame bottom	Per overall length	Horizontal	0.015
4	Center bore runout	Spindle nose	—	0.01
5	Perpendicularity of spindle top to frame bottom	Per overall length	Vertical	0.02
6	Perpendicularity of spindle to frame bottom guide blocks	Per overall length	Vertical	0.02
7	Indexing accuracy (arc sec.)	Cumulative	—	45
9	Height difference of both center lines of rotary table and tailstock	—	Vertical	0.03

RCV/RNCV

Unit: mm

No.	Inspection items	Tolerance							
		RCV-800		RCV-1000		RNCV-1201		RNCV-1501	
		Standard	With a scale	Standard	With a scale	Standard	Standard		
1	Table top flatness (concave)	Per overall length	—	0.03	0.02	0.04	0.02	0.04	0.04
2	Table top runout	—	—	0.02	0.01	0.03	0.02	0.03	0.03
3	Parallelism of table top to frame bottom	Per overall length	Horizontal	0.03	0.02	0.04	0.02	0.04	0.04
4	Center bore runout	Spindle nose	—	0.01	0.01	0.01	0.01	0.01	0.01
5	Perpendicularity of spindle top to frame bottom	Per overall length	Vertical	0.03	0.02	0.04	0.03	0.04	0.04
6	Perpendicularity of table top to frame bottom guide blocks	Per overall length	Vertical	0.03	0.03	0.04	0.03	0.04	0.04
7	Indexing accuracy (arc sec.)	Cumulative	—	15	8	15	8	15	15
8	Parallelism of center line between rotary table and tailstock to frame bottom guide blocks	Per 300mm	Vertical	0.02	0.02	0.02	0.02	0.03	0.03
9	Height difference of both center lines of rotary table and tailstock (tailstock center line should be higher)	—	Vertical	0.02	0.02	0.02	0.02	0.04	0.04

Note: The indexing accuracy above is for tables with MP scales. See P.61 for indexing accuracy of HEIDENHAIN rotary encoders.

RNCM

Unit: mm

No.	Inspection items	Tolerance							
		RNCM-251,301		RNCM-401,501		RNCM-631			
		Standard	With a scale	Standard	With a scale	Standard	With a scale		
1	Table top flatness (concave)	Per overall length	—	0.01	0.01	0.02	0.01	0.03	0.01
2	Table top runout	—	—	0.015	0.01	0.015	0.01	0.02	0.01
3	Parallelism of table top to frame bottom	Per overall length	Horizontal	0.02	0.01	0.02	0.01	0.03	0.02
4	Center bore runout	Spindle nose	—	0.01	0.005	0.01	0.005	0.01	0.01
5	Perpendicularity of spindle top to frame bottom	Per overall length	Vertical	0.02	0.01	0.02	0.01	0.03	0.02
6	Perpendicularity of table top to frame bottom guide blocks	Per overall length	Vertical	0.02	0.01	0.02	0.01	0.03	0.03
7	Indexing accuracy (arc sec.)	Cumulative	—	15	10	15	8	15	8
8	Parallelism of center line between rotary table and tailstock to frame bottom guide blocks	Per 300mm	Vertical	0.02	0.01	0.02	0.01	0.02	0.02
9	Height difference of both center lines of rotary table and tailstock (tailstock center line should be higher)	—	Vertical	0.02	0.01	0.02	0.01	0.02	0.02

Note: The indexing accuracy above is for tables with MP scales. See P.61 for indexing accuracy of HEIDENHAIN rotary encoders.

RBS

TBS

RWE/RWA
RN

RWE/RWA-B
RNCV-B

RNCM

RWB

RWB-K
RNCK

RCH
RNC

RCV
RNCV

Multi-Spindle
RWM

TWA/TN

TTNC

THNC

Multi-Spindle
TWM

RDS

RTV
RTT

RCB

NC Controllers

Accessories

Options

Technical
Information

RNCK

Unit: mm

No.	Inspection items		Tolerance	
			RNCK-631	
			Standard	With a scale
1	Table top flatness (concave)	Per overall length	0.03	0.02
2	Table top runout	—	0.02	0.01
4	Center bore runout	Spindle nose	0.01	0.005
5	Perpendicularity of table top and frame bottom	Per overall length	0.03	0.02
6	Perpendicularity of table top to frame bottom guide blocks	Per overall length	0.03	0.03
7	Indexing accuracy (arc sec.)	Cumulative	15	8
8	Parallelism of center line between rotary table and tailstock to frame bottom guide blocks	Per 300mm	0.02	0.02
9	Height difference of both center lines of rotary table and tailstock (tailstock center line should be higher)	—	0.02	0.02

Note: The indexing accuracy above is for tables with MP scales. See P.61 for indexing accuracy of HEIDENHAIN rotary encoders.

RCH/RNC

Unit: mm

No.	Inspection items		Tolerance					
			RCH-800		RCH-1000,1250 RNC-1501		RNC-2001	
			Standard	With a scale	Standard	With a scale	Standard	With a scale
1	Table top flatness (concave)	Per overall length	0.03	0.02	0.04	0.02	0.04	0.03
2	Table top runout	—	0.02	0.01	0.03	0.02	0.03	0.02
3	Parallelism of table top to frame bottom	Per overall length	0.03	0.02	0.04	0.02	0.04	0.03
4	Center bore runout	Spindle nose	0.01	0.01	0.01	0.01	0.01	0.01
7	Indexing accuracy (arc sec.)	Cumulative	15	8	15	8	15	8

Note: The indexing accuracy above is for tables with MP scales.

RBS

TBS

RWE/RWA
RN

RWE/RWA-B
RNCV-B

RNCM

RWB

RWB-K
RNCK

RCH
RNC

RCV
RNCV

Multi-Spindle
RWM

TWA/TN

TTNC

THNC

Multi-Spindle
TWM

RDS

RTV
RTT

RCB

NC Controllers

Accessories

Options

Technical
Information

Inspection Standard

NC Rotary Tables / Multi-Spindle

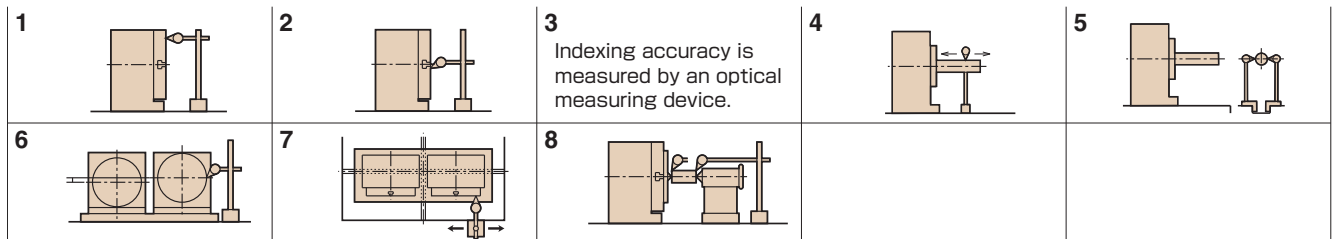

3 Indexing accuracy is measured by an optical measuring device.

RWM

Unit: mm

No.	Inspection items	Tolerance		
		RWM-160	RWM-200	
1	Spindle top runout	0.01	0.01	
2	Center bore runout	0.01	0.01	
3	Indexing accuracy(arc sec.)	25	20	
4	Parallelism of rotary axis center to base bottom	0.02	0.02	
5	Parallelism of rotary axis center to bottom guide blocks(Perpendicularity)	0.02	0.02	
6	Difference between both center heights	0.02	0.02	
7	Difference of spindle end	0.02	0.02	
8	Height difference of both center lines of rotary table and tailstock	0.03	0.03	

Note 1: If the base has no guide block, "base bottom guide block" in the above instructions (Nos. 5) should be construed as "base bottom".

NC Tilting Rotary Tables

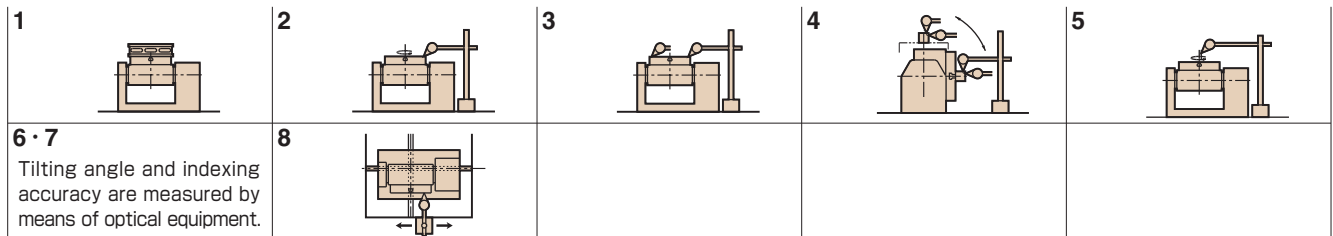

6·7 Tilting angle and indexing accuracy are measured by means of optical equipment.

TBS

No.	Inspection items	Tolerance		
		TBS-130	TBS-160	TBS-250
		Standard	Standard	Standard
2	Spindle(Table) top runout	0.01	0.01	0.01
3	Parallelism of spindle(table) top to frame bottom	0.015	0.015	0.015
4	Parallelism of tilt axis center to frame bottom	0.02	0.02	0.02
5	Center bore runout	0.01	0.01	0.01
6	Tilting accuracy(arc sec.)	30	30	40
7	Indexing accuracy(arc sec.)	20	20	20
8	Parallelism(Perpendicularity) of rotary axis center line to guide blocks	0.015	0.015	0.015

- RBS
- TBS
- RWE/RWA
RN
- RWE/RWA-B
RNCV-B
- RNCM
- RWB
- RWB-K
RNCK
- RCH
RNC
- RCV
RNCV
- Multi-Spindle
RWM
- TWA/TN
- TTNC
- THNC
- Multi-Spindle
TWM
- RDS
- RTV
RTT
- RCB
- NC Controllers
- Accessories
- Options

Technical Information

NC Tilting Rotary Tables

TWA/TN

Unit: mm

No.	Inspection items		Tolerance					
			TN-101	TWA-130	TWA-160	TWA-200	TN-320	TN-450
			Standard	Standard	Standard	Standard	Standard	Standard
1	Table top flatness (concave)	Per overall length	—	—	—	—	0.01	0.02
2	Spindle (Table) top runout	—	0.01	0.01	0.01	0.01	0.015	0.015
3	Parallelism of spindle (table) top to frame bottom	Per overall length	0.015	0.015	0.015	0.015	0.02	0.02
4	Parallelism of tilt axis center to frame bottom	Per overall length	0.02	0.02	0.02	0.02	0.02	0.02
5	Center bore runout	Spindle nose	0.015	0.01	0.01	0.01	0.01	0.01
6	Tilting accuracy (arc sec.)	Cumulative (0°~+90°)	45	45(15)	45	45	45	90
		Cumulative (-30°~+90°)	—	—	60	60	60	—
7	Indexing accuracy (arc sec.)	Cumulative	40	40(15)	30	30	20	15
8	Parallelism (Perpendicularity) of rotary axis center line to guide blocks	Per overall length (90 degree)	0.015	0.015	0.015	0.015	0.02	0.02

Note 1: For item 8, values differ depending on the mounting direction of the guide block. Note 2: The table tops of TN-101 and TWA-130, are the ends of the spindles. Note 3: Values in () for TWA-130 are accuracy for tables with rotary encoders and MP scales for high precision. (Please see P.61)

TTNC/THNC

Unit: mm

No.	Inspection items		Tolerance					
			TTNC-631		TTNC-1001		THNC-251,301	
			Standard	With a scale	Standard	With a scale	Standard	With a scale
1	Table top flatness (concave)	Per overall length	0.03	0.03	0.04	0.04	0.01	0.01
2	Table top runout	—	0.02	0.02	0.03	0.03	0.015	0.015
3	Parallelism of table top to frame bottom	Per overall length	0.03	0.03	0.04	0.04	0.02	0.02
4	Parallelism of tilt axis center to frame bottom	Per overall length	0.03	0.03	0.04	0.04	0.02	0.02
5	Center bore runout	Spindle nose	0.01	0.01	0.01	0.01	0.01	0.01
6	Tilting accuracy (arc sec.)	0°~+90°	60	15	60	15	60	60
7	Indexing accuracy (arc sec.)	Cumulative	15	8	15	8	15	10
8	Perpendicularity of table top to frame bottom guide blocks (Parallelism)	Per overall length (90 degree)	0.02	0.02	0.02	0.02	0.02	0.02

Note 1: The indexing accuracy above is for tables with MP scales. See P.61 for indexing accuracy of HEIDENHAIN rotary encoders. Note 2: For item 8, values differ depending on the mounting direction of the guide block.

NC Tilting Rotary Tables / Multi-Spindle

1		2		3		4		5	
6		7	Tilt accuracy is measured using an optical scale.	8	Indexing accuracy is measured by an optical measuring device.	9		10	
11									

TWM

Unit: mm

No.	Inspection items		Tolerance	
			TWM-160	TWM-250
1	Spindle top flatness (concave)	Per overall length	0.01	0.01
2	Spindle top runout	—	0.01	0.01
3	Difference between average heights of both spindle tops	0 degree	0.02	0.02
4	Parallelism of spindle top to base bottom	Per overall length	0.015	0.015
5	Parallelism of tilt axis center to base bottom	Per overall length	0.02	0.02
6	Center bore runout	Spindle nose	0.01	0.01
7	Tilting accuracy (arc sec.)	0°~+90°	60	60
8	Indexing Accuracy (arc sec.)	Cumulative	30	20
9	Table center distance	—	±0.02	±0.02
10	Difference between both center heights	90 degree	0.02	0.02
11	Parallelism of tilt axis center to frame bottom guide blocks.	Per 300mm (90 degree)	0.015	0.015

RBS

TBS

RWE/RWA
RN

RWE/RWA-B
RNCV-B

RNCM

RWB

RWB-K
RNCK

RCH
RNC

RCV
RNCV

Multi-Spindle
RWM

TWA/TN

TTNC

THNC

Multi-Spindle
TWM

RDS

RTV
RTT

RCB

NC Controllers

Accessories

Options

Technical
Information

NOTES

OPERATION ENVIRONMENT AND MAINTENANCE RECOMMENDED TO KEEP PERFORMANCE AND FUNCTION

- **Do not use any coolant of chlorine or strong alkaline.**
- Do not use any corrosive gas, water, steam or chemicals damaging sealing parts.
- **Lubricant is indispensable** in order to operate a rotary table smoothly and to maintain its functions for a long time. **Supply a recommended lubricant (in the operation manual) to the rotary table before operation. Change all the lubricant periodically.**
- If a lot of cutting chips, (generated by machining,) accumulate on some sections of rotary table, install adequate covers for protection.
- Operate a rotary table within the specified range of temperature.
- Depending upon the operation environment, there is a possibility of dew condensation which may cause a malfunction or a rust problem of electrical components, so provide air-purging inside the motor cover. (Do not close the outlet of exhaust air.) **See Fig. 1.**
- When assembling a faceplate or a fixture with the main spindle, make the inner diameter section as the reference for fitting as shown in **Fig. 2.**
- Keep the clearance with 3mm or more between a Faceplate or a fixture and a Rotary table. Otherwise, cutting chips may impede the rotation of the main spindle or the waterproof capability of the seals. **See Fig. 2.**

Fig. 1

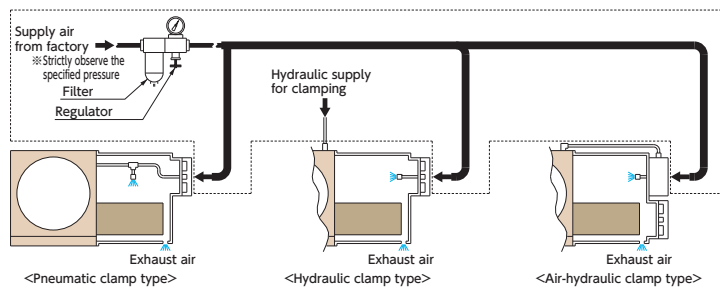
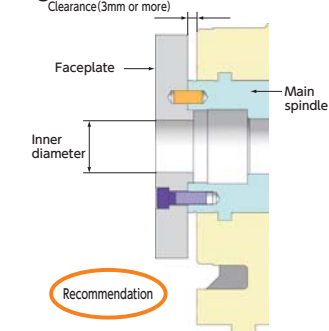

Fig. 2



SETTING ON MACHINE TOOL AND PREPARATION BEFORE USE

- When moving a rotary table by a hanging method, observe the specified method in the operation manual.
- To fix a rotary table on a machine tool, use the specified fixing parts and follow the specified method.
- Connect each interface cable in accordance with the instructions on the electrical drawing.
- Provide protective measures to avoid adding extraordinary force to any piping or any joint for each interface cable and each connector, to induce any damage, during the operation of a machine tool with a rotary table.
- Each piping is to be connected to the specified input port (connecting port) stated in the outlook drawing.
- Regarding each fluid to be supplied to a rotary table, make sure that **maximum pressure does not exceed the specified pressure** even if there is a pressure variation due to the pressure source or other factors.
- Refer to the recommendable flow chart on Page 67 for the NC control at the time of table clamping.

DAILY OPERATION, PERIODICAL CHECK AND OTHERS

- Make sure that the weight and size of the workpiece does not exceed the specified value of the workable force during machining.
- In case any abnormality is realized during operation, stop machining immediately.
- When any human work is carried out within the operational area of machine tool, be sure to turn off the power for the machine tool as well as the Tsudakoma controller.
- When restarting from a long stoppage, perform a warm-up operation of the rotary table.
- Do not make any conversion of a rotary table without Tsudakoma's consent.

Overseas Distributors

U.S.A.	KOMA PRECISION, INC. Address: 20 Thompson Road, East Windsor, CT 06088 Tel: +1 860 627 7059 Fax: +1 860 623 4132 E-mail: info@komaprecision.com Website: www.komaprecision.com	KOREA	Daesung Hi-Tech Co., Ltd. Head Office Address: 10, Techno-daero 2-gil, Hyeonpung-myeon, Dalseong-gun, Daegu, 43020, KOREA Tel: +82-53-608-3700 Fax: +82-53-593-3663 E-mail: dsht@topdsht.com Website: http://www.topdsht.com/
BRASIL	TMTA Brasil Comercio e Representacoes Ltda. Address: Rua Henrique Wiesel, 795-Distrito Industrial CEP13.456-165-Santa Barbara d' Oeste-SP-Brazil Tel: +55 19 3455-0022 E-mail: ortega.tmta@tsudakoma.com.br		Seoul Office Address: 703, (BaeksangStarTower 1ST)65, Digital-ro 9-gil, Geumcheon-gu, Seoul, KOREA Tel: +82-2-830-1940 Fax: +82-2-830-1942 E-mail: ss.kim@topdsht.com
GERMANY	THD GmbH Address: Spiesheimer Weg 19, 55286 Worrstadt Tel: +49 6732 9379 0 Fax: +49 6732 9379 29 E-mail: info@thdgbmh.de Website: www.thdgbmh.de	TAIWAN	SHIN TONG LONG TRADING CO., LTD. Address: 7F No.3 Kuei Feng Street, Tai Shan Shiang, Taipei Hsien, TAIWAN Tel: +886 2 2908 7139 Fax: +886 2 2907 1929 E-mail: stltpe@ms27.hinet.net Website: www.stlco.net
ITALY	TEOMA S.R.L. Address: Via M. Idiomi, 1/11 -20090 Assago Milano Tel: +39 02 4571 3787 Fax: +39 02 4570 5320 E-mail: sales@teomasrl.it Website: www.teomasrl.it	CHINA	TSUDAKOMA (SHANGHAI) CO., LTD. Address: 7F, Room.C, D building, No.2337, Gudai Road, MinhangDistrict, Mapletree Business City Shanghai Shanghai 201100 Tel: +86 21 6432 6538 Fax: +86 21 6432 5579 E-mail: info2@tsudakoma.co.jp Website: www.tsudakoma.co.jp
FRANCE	DOGA Address: ZA Pariwest - 8, avenue Gutenberg - BP53 - 78311 Maurepas cedex Tel: +33 1 3066 4141 Fax: +33 1 3066 4199 E-mail: doga@dog.fr Website: www.doga.fr	THAILAND	Bestcooper Co., Ltd. Address: 84/160,1 st floor, Soi 15, The Living Village, Moo 5, Liapkhlong Rangsit Rd., Tambon Bangpoon,Amphoe Mueang Pathumtani, Pathumtani 12000, THAILAND. Tel: (+66) 2958-8928 Fax:(+66) 2958-8927 E-mail: sales@bestair.co.th
SPAIN	SERKIDE Integral Services Address: Poligono Industrial de Itziar Parcela M-4 · 3 Apdo. 10 20820 Deba - Itziar (Gipuzkoa) Spain TEL: +34-943-19-92-62 E-mail: accesorios.robotica@serkide.com Website: http://www.serkide.com/	INDONESIA	PT.GANSA TECHNO CENTER, Bandung Indonesia Address: Kopo Plaza G-5, Jl. Peta Lingkar Selatan, Bandung 40233, INDONESIA Tel: (+62) 22 607 1637-8 Fax: (+62) 22 607 1639 E-mail: info@gansa-techno.com Website: gansa-techno.com
INDIA	TSUDAKOMA SERVICE INDIA PVT.LTD Address: 404, Meadows Building, Sahar Plaza Complex, Andheri (EAST) Mumbai-400059, Maharashtra, INDIA Tel: +91-22-2825-2826, +91-22-2825-2827 Fax: +91-22-2825-2828		

● This catalog includes strategic items prescribed in the Japanese Foreign Exchange and Foreign Trade Act. In order to export such items, permissions must be obtained in accordance with the aforementioned law.

TSUDAKOMA Corp.

Nonoichi Plant 5-100 Awada, Nonoichi, Ishikawa 921-8529 Japan
Phone: +81-76-294-5111 Fax: +81-76-294-5157
http://www.tsudakoma.co.jp E-mail:kexport@tsudakoma.co.jp



This catalog was printed in vegetable oil ink, using the environmentally friendly waterless offset printing process.

NE11-19N
2019-08