

AMWD-WS

PNEUMATIC HOLD DOWN CLAMPS



★ **One Point**
Magnetic sensor mountable!



AMWD16-WS

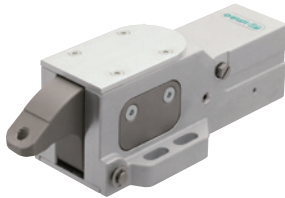

AMWD25-WS

Body	Clamp Arm
AC7A aluminum Anodized	SCM415 steel Carburized-hardened Electroless Nickel Plated

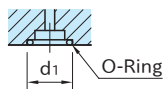
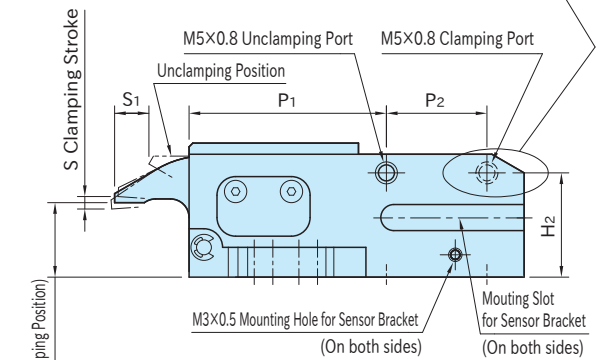
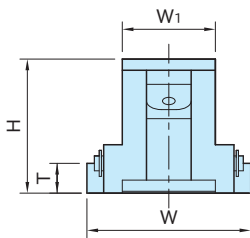
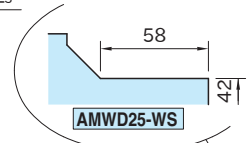
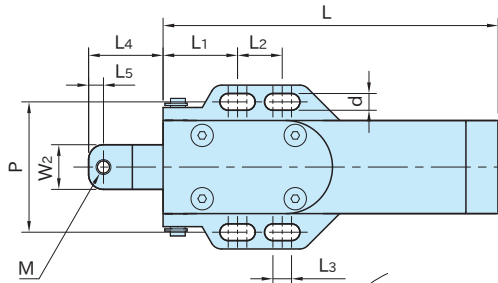

Section X-X

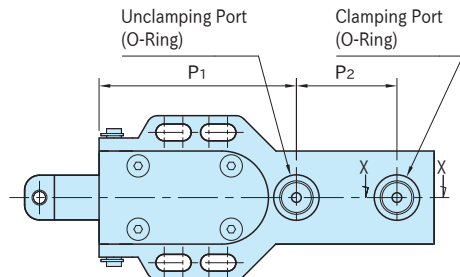

Part Number	W ₂	L ₄	M	L ₅	H ₁	S	S ₁	L	W ₁	H	W	T	d	L ₁	L ₂	L ₃
AMWD16-WS	12	20	M4×0.7	4	20	2	9	90	25	36	44	8	4.5	20	12	5
AMWD25-WS	18	32	M6×1	6	30	3	15	135	40	54	65	12	6.5	30	20	8

Part Number	P	d ₁	P ₁	P ₂	H ₂	Operating Air Pressure (MPa)	Clamping Force (N) *	Furnished O-Ring	Weight (g)
AMWD16-WS	35	12.2	53	27	28	0.3 - 1.0	140	P 9	250
AMWD25-WS	53	18	84	38	33		320	P14	850

Supplied With

2 of O-Ring

*) The clamping forces above are at 0.5 MPa.

Performance Curve

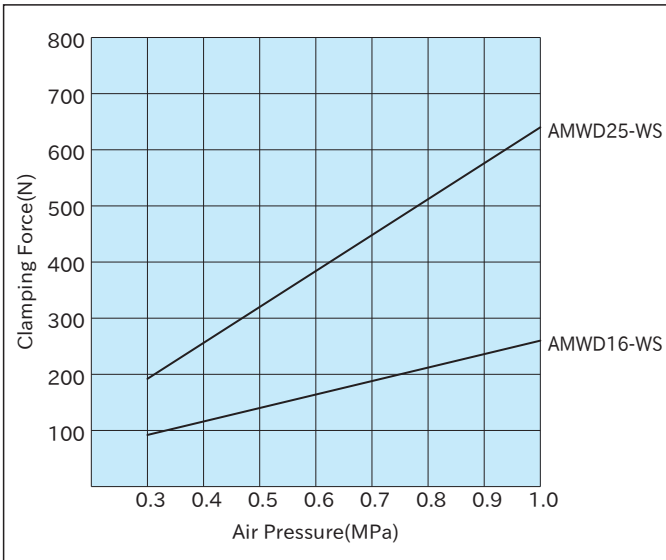

Related Product Page

[AMWD-WS-B](#) SENSOR BRACKETS

Feature

- Wedge mechanism provides 150% clamping force.

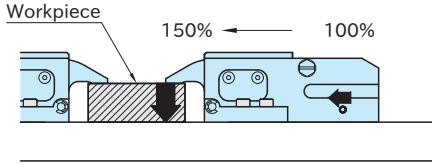

- The allowable counterforce is shown in the chart below.
- Wedge mechanism prevents the clamping force from immediate decrease if air pressure lowers.
 - Note: The clamping force may be decreased by excessive vibration.

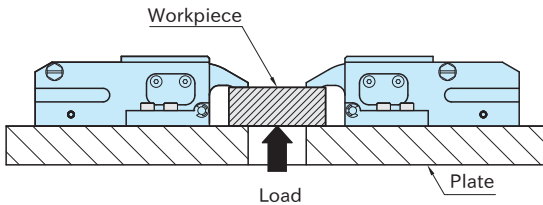

Allowable Counterforce (Per Clamp)

Part Number	Allowable Force (kN)
AMWD16-WS	1
AMWD25-WS	2.2

Note

- Use clean air by removing dust with filter or draining with dryer.
- Impure compressed air may cause malfunction of the products.
- Using lubricator is recommended.
- Use the clamp within the clamping stroke.

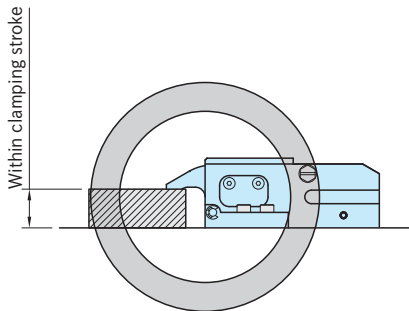

The wedge mechanism works to clamp the workpiece securely.

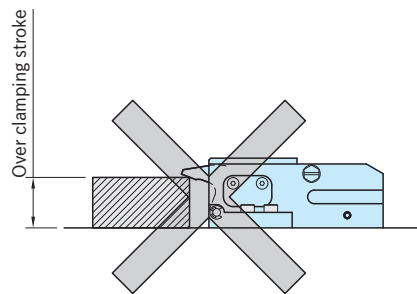

The wedge mechanism does not work.

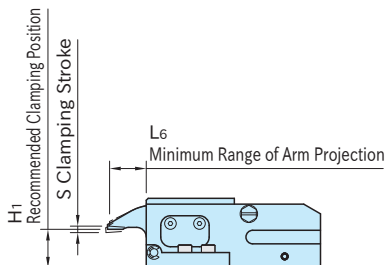

Part Number	S	H ₁	L ₆
AMWD16-WS	2	20	19
AMWD25-WS	3	30	30.5

How To Use

■ With Side Ports

- Ensure that the furnished air block plugs are attached to the bottom ports.
- Remove the air block plugs on the side ports and connect the piping.
- Refer to the figure below for the hole preparation.

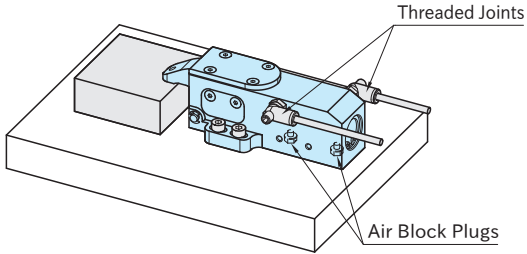

■ With Bottom Ports

- Ensure that the furnished air block plugs are attached to the side ports.
- Remove the air block plugs on the bottom ports and attach O-rings (included) to it.
- Plate surface must be flat ($\nabla^{6.3}$) to get the bottom ports sealed up.
- Refer to the figure below for the hole preparation.

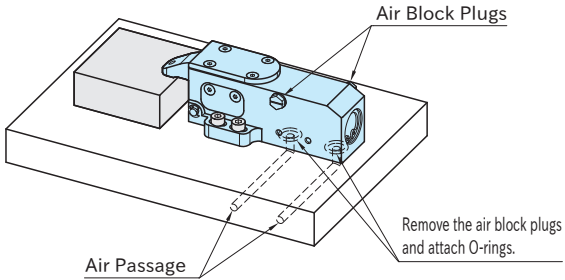

■ Hole Preparation

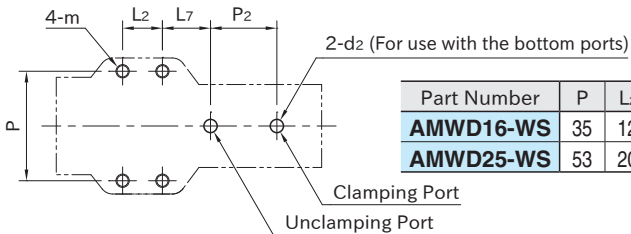

Part Number	P	L ₂	L ₇	P ₂	m	d ₂
AMWD16-WS	35	12	21	27	M4×0.7	φ2 - φ4
AMWD25-WS	53	20	34	38	M6×1	φ2 - φ6